

Tennessee Agricultural Enhancement Program



2023 Application A

**Genetics • Livestock Equipment • Hay Equipment
 Herd Health • Livestock Solutions • Dairy Solutions
 Row Crop Solutions • Poultry Grower • Swine Producer
 Working Structures & Fence-line Systems**

**Application Period
 October 1 – 7, 2023**

Application Guide

TAEP Investments.....2	Livestock Equipment12	Hay Equipment.....34
Commissioner’s Message.....3	Genetics14	Livestock Solutions.....36
TAEP Overview4	Herd Health.....20	Poultry Grower38
Eligibility Requirements.....6	Working Structures & Fence-line Systems.....22	Swine Producer40
Program Requirements.....7	Dairy Solutions30	How to Apply42
Master Producer Requirements.....8	Row Crop Solutions32	Instructions for Application A.....44
Beginning Farmer Option.....10		Application A Form45

TAEP Investments - 2005 to 2022

EACH TAEP DOLLAR GENERATES



\$6.55

IN LOCAL ECONOMIES.*

*Source: The University of Tennessee Agri-Industry Modeling & Analysis Group

More than \$246,463,809 invested in 80,860 producer projects from FY06 - FY22

Genetics

Assists producers in improving the genetics in their operations, increasing the quality, value, marketability, and reputation of Tennessee livestock.

FY06 - FY22: 17,824 projects — \$20,013,267

Livestock Equipment

Improves a farmer's ability to manage livestock properly and safely on the farm with items like squeeze chutes, creep feeders, feed bins, and working systems.

FY06 - FY22: 37,250 projects — \$70,889,592

Hay Equipment

Assists farmers in improving hay production.

FY20 - FY22: 2,767 projects — \$14,310,932

Hay Storage

Assists farmers in building hay barns, improving storage and management of forages critical to improving herd nutrition.

FY07 - FY21: 11,357 projects — \$61,295,440

Herd Health

Assists cattle producers in improving whole herd health by encouraging a preventative vaccination protocol.

FY20 - FY22: 523 projects - \$805,461

Livestock Solutions

Assists farmers in building feed storage sheds, silos, and installing feed management equipment, improving feed quality and cost efficiency.

FY08 - FY22: 2,959 projects — \$24,706,120

Row Crop Solutions

Assists farmers in managing, storing, and drying grains, providing higher returns, and marketing flexibility.

FY09 - FY22: 3,156 projects — \$31,607,391

Permanent Working Structures

Improves farm safety, functionality, and longevity of livestock working equipment by providing a protective cover.

FY15 - FY22: 1,961 projects — \$5,520,482

Producer Diversification

Assists producers in diversifying their farming operations. Sectors include agritourism, fruit and vegetables, honey bees, horticulture, organics, and value-added products.

FY06 - FY22: 2,627 projects — \$15,287,413

Poultry Grower

Assists commercial poultry growers in operational improvements.

FY16 - FY22: 381 projects — \$1,641,602

Dairy Solutions

Improves quality of Tennessee milk.

FY21 - FY22: 55 projects — \$386,110

Message from Commissioner Hatcher



Dear Tennessee Farmers and Foresters,

For eighteen years now, the Tennessee Agricultural Enhancement Program (TAEP) has truly enhanced agriculture across our great state. The numbers speak for themselves. Since 2005, more than \$246 million has been invested in 80,860 producer projects. This tremendous impact proves that TAEP is a dynamic and highly effective cost-share program.

The Tennessee Department of Agriculture appreciates the farmers and foresters who use these funds to improve their operations. Every dollar spent strengthens the agriculture and forestry industries and bolsters our rural economies. Your participation enables you to maximize profits while increasing efficiency. Perhaps most importantly, these investments have helped you provide food, fuel, fiber, and wood products to the citizens of Tennessee and beyond.

I extend a sincere thank you to Governor Bill Lee and the Tennessee General Assembly for their continued support of TAEP. They recognize the importance of our state's number one industry. My gratitude also goes to the TAEP Advisory Committee. Each year, the members meet to provide fresh and relevant ideas to improve the program. The group's willingness to serve in an advisory role does not go unnoticed.

Thank you again for your continued support of and interest in the Tennessee Agricultural Enhancement Program. Because of you, the future of our industry is bright.

A handwritten signature in black ink, which appears to read "Charlie Hatcher". The signature is stylized and fluid, with a large loop at the end.

Charlie Hatcher, D.V.M.
Commissioner of Agriculture

TAEP Overview

Please read this application booklet as there are changes to requirements and program items.

Updates for 2023-2024

Eligibility Requirement #4 – Farm Operation clarification

- To operate a farm means to share in the expenses, profits, and/or management of farm operation.
 - A farm may involve the production of multiple agricultural products and may have more than one location in Tennessee.
 - A diversified farm with multiple species of livestock, crops, and/or multiple locations is considered a single operation regardless of tax filings or organizational structure.
- **If two or more individuals participate in the operation of the farm, only one individual is eligible to apply for TAEP Application A cost share.**

Reimbursement Requirements #2 – Receipt clarification

- Quotes and purchase orders do not represent a purchase and are not considered receipts.
- Proof of payment may be required.

Verification Requirements – Compliance clarification

- Applicants who fail to comply with minimum use requirements may be required to repay any portion of or all of funds distributed to them under TAEP.
- Failure to comply with all aspects of the cost share guidelines may result in denial of applicant approval, denial of reimbursement payments, repayment of cost share funds, and/or suspension from future TAEP funding cycles.
- Providing any false, fraudulent, or misleading information may result in suspension of applicant's operation, civil litigation, and/or criminal prosecution.

Beginning Farmer Option

- Qualifying applicants will be eligible for select programs (Genetics, Livestock Equipment, & Row Crop Solutions).

Livestock Equipment

- Added self-unloading inline hay trailer
- Reprioritized eligible items to focus on long term investments
- Removed the eligibility of used items due to verification concerns
- Added minimum purchase requirements for select items for best practice management

Genetics

- Breeds with Genomic Enhanced EPDs (GE-EPD) – eligible GE-EPDs required for cost share reimbursement up to \$2,000 (\$1,000 reimbursement for 0.15 accuracies is not available).
- Breeds that do not offer Genomic Enhanced EPDs – eligible true NCE EPDs with minimum 0.15 accuracies required for cost share reimbursement up to \$1,000.
- Bulls must have eligible EPDs between October 1, 2023 and date of purchase date.
- Bulls that do not meet all eligibility requirements between October 1, 2023 and date of purchase will be denied cost share reimbursement.
- **Buyer must communicate with the seller prior to purchasing to ensure bull meets all TAEP eligibility requirements.**

Working Structures & Fence-line Systems

- Formerly "Permanent Working Structures"
- Added fence-line concrete bunk and hay feeding systems which were previously available in Livestock Solutions

Hay Equipment

- Added hay accumulator, hay grapple, multi bale hay spear
- Quotes and purchase orders do not represent a purchase and are not considered receipts.
- **A receipt is required for cost share reimbursement.**

Poultry Grower

- Added program back to Application A after eight years as a separate application booklet (Application C)
- Allows applicants the option to apply online

Swine Producer

- Created standalone program for swine which were previously under Livestock Solutions
- Added curtains, farrowing crates, farrowing crate flooring, feed bin, feed bin scales, heaters, manure/lagoon pump, manure spreader/injector, nursery pens, propane tanks, ventilation fans, ventilation doors

Reimbursement Maximums

Each program has a reimbursement payment maximum. The amount of payment is based upon a cost share percentage (35% or 50%) of expenses incurred for eligible program items.

Final program reimbursement maximums will be determined based upon overall demand for cost share funding and specified on approval documentation.

Cost Share Percentages & Master Certification

All approved applicants are eligible for 35% (Standard Producer) cost share with the exception of applicants approved for the Beginning Farmer Option. For applicants wanting to qualify for 50% cost share (Master Producer), an eligible master producer certificate is required at time of reimbursement (not at time of application). Courses to obtain certificates must be completed by the applicant. Certificates must be issued after January 1, 2020 to be considered current for TAEP. See pp. 8 & 9 for additional information on master producer requirements.

Applicants qualifying for the Beginning Farmer Option will be reimbursed at 50% cost share and must complete the required educational certification (UT Farming Fundamentals or TSU New Farmer Academy) by the reimbursement deadline to qualify for reimbursement. There will not be a 35% cost share option. See pp. 10-11.

Program Change

Applicant will not be allowed to change program request after the application period ends on October 7, 2023.

Application Period

The 2023 application period is open for seven days: October 1-7, 2023.

Eligible Purchase Dates

Program purchases can be made starting October 1, 2023. All purchases must be completed by the program reimbursement request deadline. **All receipts must be in the name of the applicant approved for cost share funding.**

Approval Notifications

Approval notifications are scheduled to be mailed in mid-December. Reimbursement packets will be mailed in January 2024.

Reimbursement Request Deadlines

The reimbursement request deadline for Livestock Equipment and Hay Equipment is April 1, 2024. The reimbursement request deadline for Genetics is June 1, 2024. All other TAEP programs have a reimbursement deadline of August 1, 2024.

2023 TAEP Application A		
Program	Reimbursement Maximum*	Reimbursement Request Deadline
Livestock Equipment	\$2,000	April 1, 2024
Hay Equipment	\$6,000	
Genetics	\$2,000	June 1, 2024
Working Structures & Fence-line Systems	\$4,000	August 1, 2024
Herd Health	\$6,000	
Livestock Solutions	\$6,000	
Poultry Grower	\$6,000	
Swine Producer	\$6,000	
Dairy Producer	\$10,000	
Row Crop Solutions	\$12,000	
*Final maximums will be determined based upon overall demand for cost share funding.		

Eligibility Requirements

1. Applicant must be a citizen of the United States of America or lawfully present in the United States.
2. Applicant must be at least 18 years old at time of application.
3. Applicant must be a Tennessee resident residing in Tennessee. *Documentation, including a current Tennessee Driver/Identification license, may be requested to verify applicant has established residency in Tennessee.*
4. Applicant must be operating a farm* in Tennessee.

*** To operate a farm means to share in the expenses, profits, and/or management of farm production.** *A farm may involve the production of multiple agricultural products and may have more than one location in Tennessee. A diversified farm with multiple species of livestock, crops, and/or multiple locations is considered a single operation regardless of tax filings or organizational structure.*

If two or more individuals participate in the operation of the farm*, only one individual is eligible to apply for TAEP Application A cost share.

5. Applicant must have filed a Federal IRS Schedule F (Form 1040), Profit or Loss from Farming, within the last two years (2021 or 2022).
Applicant will not be required to submit a copy of their Schedule F at the time of application. However, applicant may be asked to submit a copy of their Schedule F prior to TAEP approval to verify their farming operation. If your operation does not file a Schedule F, please contact TAEP about alternate documentation (Schedule C or Schedule K) to verify farming status.
6. Applicant must meet at least one of the minimum livestock/acreage requirements for selected program. Verification of minimum requirements may be requested prior to approval.
 - Head of Livestock = maximum number of single type, regardless of sex or age, at any one time during the last 12 months
 - Hay Acreage = acres of hay production; first cutting only
 - Row Crop Acreage = acres in row crop production of corn, cotton, soybeans, and/or wheat
7. Applicant must have current (not expired) documentation (certificate or permit) based on type of producer at time of application. Documentation must be in the name of the applicant. No substitutions allowed.

Beef Quality Assurance Certification (BQA) for beef and dairy cattle

- BQA certification must be renewed every three years and be current at time of application.
- BQA is an educational class on cattle management and care. Courses are available in-person and online.
- In-person certification – administered in-person by your local UT/TSU Extension office (utextension.tennessee.edu)
- Online certification – two options
 - Tennessee Cattlemen’s Association (TCA), www.tncattle.org, 615-896-2333, info@tncattle.org
 - Beef Quality Assurance, www.bqa.org

Pork Quality Assurance Plus Certification (PQA) for swine

- PQA Plus certifications must be renewed every three years and be current at time of application.
- PQA Plus is a two-hour educational course sponsored by the Tennessee Pork Producers Association (TPPA).
 - Contact TPPA for additional information on PQA Plus classes at: 615-274-6533 or porkpromotn@tds.net

Tennessee Department of Agriculture (TDA) Dairy Permit for dairy cattle, goats, and sheep

- Dairy must be permitted by TDA to be eligible as a dairy at time of application.
 - Contact TDA Consumer and Industry Services Division for dairy permit information at 615-837-5536.

Tennessee Department of Agriculture may:

- Accept, modify, or reject any or all applications or requests.
- Modify program criteria, approval, and payment processes.
- Request additional information from the applicant.
- Provide partial funding that may be less than the full amount requested.
- Deny payments for projects that do not meet requirements.

Program Requirements

Application

1. Applications must be submitted during the application period October 1 – 7, 2023.
 - Applications may be submitted by one of the following methods:
 - Online — October 1 - 7, 2023
 - Mail — applications must have a postmark date ranging from October 1 - 7, 2023
 - Hand delivery between October 1 – 7, 2023 during normal business hours. Contact TAEP office prior to hand delivery in 2023.
 - Applications are not accepted by fax, email, or text.
 - Applications are ineligible if postmarked or received prior to October 1 or after October 7, 2023.
2. Applicant may request one (1) cost share program. **Applicant will not be allowed to change cost share program request after the application period ends on October 7, 2023.**
3. Applicant may only submit one Application A per application period. *Refer to eligibility requirement #4 (p.6) if two or more individuals participate in the operation of the farm.*
4. Applicant will be notified in writing of approval or disapproval. Notifications will be mailed in mid-December. **Applicant must alert TAEP office if notification is not received by mid-January.**
5. Reimbursement packet may include additional program requirements and cost share guidelines.

Reimbursement

1. Receipts dated prior to October 1, 2023 are not eligible. **All items, regardless of backorder status, must be purchased by the program reimbursement deadline.** Backordered items may be ineligible for cost share if not delivered to the farm by the program deadline.
2. Receipts must be in the name of the applicant approved for cost share funding. Quotes and purchase orders do not represent a purchase and are not considered receipts. Proof of payment may be requested to verify purchase.
3. Receipts for in-kind services are not eligible. Trade-in value is not eligible.
4. Used equipment, used materials, and leased equipment are not eligible for cost share reimbursement unless otherwise noted.
5. Labor provided by applicant is not eligible for cost share reimbursement. Labor is for structures only.
6. Applicant cannot be reimbursed for purchases from a business where applicant participates in ownership (producer cooperatives excluded).
7. Applicants cannot combine projects or attach items to another applicant's project. Applicants cannot submit multiple reimbursement requests for the same purchased item.
8. Reimbursement documentation must be postmarked or uploaded to your TAEP Online Account Portal by the reimbursement request deadline. Additional processing time is required for incomplete requests and requests submitted within one month of the program deadline. It is recommended you submit your reimbursement request as soon as your project is completed.
9. There can only be one reimbursement payment per program approval. Projects must be completed by reimbursement deadline.

Verification

1. Applicant must utilize equipment and structures reimbursed with cost share funds for the intended purpose of the program for a minimum of **five (5)** continuous years from date of purchase. Applicants who fail to comply with minimum use requirements may be required to repay any portion of or all of the funds distributed to them under TAEP.
2. Site visits relating to the performance of the project before, during, and after completion may take place. Site visits may include verification of cost share guidelines and program eligibility to ensure applicants meet eligibility and minimum livestock/acreage requirements for chosen program(s).
3. Failure to comply with all aspects of the cost share guidelines may result in denial of applicant approval, denial of reimbursement payments, repayment of cost share funds, and/or suspension from future TAEP funding cycles.
4. Providing any false, fraudulent, or misleading information may result in suspension of the applicant's operation, civil litigation, and/or criminal prosecution.

50% Master Producer Requirements

Master Producer Programs

The University of Tennessee offers several educational programs for the agricultural industry. These programs are designed to provide hands-on experience in current management practices that are important to the profitability and sustainability of the industry.

All approved applicants are eligible for 35% (Standard Producer) cost share with the exception of applicants approved for the Beginning Farmer Option. For applicants wanting to qualify for 50% cost share (Master Producer), an eligible master producer certificate is required at time of reimbursement (not at time of application). Courses to obtain certificates must be completed by the applicant. Certificates must be issued after January 1, 2020 to be considered current for TAEP.

Applicants qualifying for the Beginning Farmer Option will be reimbursed at 50% cost share and must complete a required educational certification (UT Farming Fundamentals or TSU New Farmer Academy) by the reimbursement deadline to qualify for reimbursement. There will not be a 35% cost share option for the Beginning Farmer Option. See pp. 10-11.

Eligible Courses by Program

Program	Eligible Courses	Certificate Eligibility
Genetics	Master Beef Master Small Ruminant Master Dairy Master Farm Manager Master Farm Family Health & Wellness	Certificate issued January 1, 2020 or after
Hay Equipment		
Livestock Equipment		
Livestock Solutions		
Working Structures & Fence-line Systems		
Dairy Solutions	Master Dairy Master Farm Manager Master Farm Family Health & Wellness	
Row Crop Solutions	Master Row Crop Master Farm Manager Master Farm Family Health & Wellness	
Poultry Grower	Master Commercial Poultry Master Farm Manager Master Farm Family Health & Wellness	
Swine Producer	Master Farm Manager Master Farm Family Health & Wellness	
Herd Health	<i>Not Applicable</i>	

TAEP Beginning Farmer Option

Program	Eligible Courses	Certificate Eligibility
Genetics	UT Farming Fundamentals TSU New Farmer Academy	Certificate issued January 1, 2020 or after
Livestock Equipment		
Row Crop Solutions		

50% Master Producer Requirements

Master Certification & TAEP 50% Cost Share

To be eligible for 50% cost share, an approved applicant must complete an eligible master course **prior to submission of their reimbursement request.**

- Certificates must be issued **2020 or after** to be considered current for TAEP.
- Courses to obtain certificates must be completed by the applicant approved for TAEP cost share. No substitutions allowed.
- Copy of current certificate must be submitted with reimbursement request.

Course Schedules

Contact your local UT/TSU Extension office to inquire about educational course offerings.

- University of Tennessee | utextension.tennessee.edu
- Tennessee State University | tnstate.edu/extension

Master Producer Recertification

If you received your master certification after **January 1, 2020**, you will be eligible for 50% cost share for the 2023-2024 TAEP program. **Recertification is required if course was completed prior to 2020.**

If you are unsure when you earned your master course certification, please contact your local UT/TSU Extension Agent for assistance.

Contact your local UT/TSU Extension office to inquire about your master course certification needs.

- University of Tennessee | utextension.tennessee.edu
- Tennessee State University | tnstate.edu/extension

The following chart indicates master producer certificate eligibility by TAEP program year.

TAEP Program Year	Master Certificate Eligibility
2023-2024	Certificate issued January 1, 2020 or after
2024-2025	Certificate issued January 1, 2021 or after
2025-2026	Certificate issued January 1, 2022 or after
2026-2027	Certificate issued January 1, 2023 or after

BQA Certification vs. Master Producer Certification

Beef Quality Assurance (BQA) certification is required at time of application for cattle producers only. Training courses are offered in-person by your local UT/TSU Extension office or online. Course focuses on cattle management and care and is approximately two hours in length.

Master Producer certification is required prior to submission of reimbursement request for applicants seeking to be eligible for 50% cost share. Master Producer certificates are issued by UT/TSU Extension. Course involves multiple education sessions focusing on production and marketing.

Beginning Farmer Option

Beginning Farmer Option

IMPORTANT: If an applicant currently meets the minimum requirements for **any** TAEP Application A program, they **are not eligible** for the Beginning Farmer Option. However, they may apply for the program for which they are eligible.

This program option allows qualifying beginning farmers, who do not meet the current minimum requirements for any TAEP Application A program, the opportunity to participate with **reduced minimum requirements** in select programs (Genetics, Livestock Equipment, or Row Crop Solutions). The purpose of this option is to help the beginning farmer applicant improve their operation with the goal of meeting minimum livestock/acreage requirements in the future.

TAEP allows beginning farmers to participate in the Beginning Farmer Option for **two consecutive** years if they meet the Beginning Farmer Option requirements except for being a first time TAEP applicant.

Beginning Farmer Requirements

To qualify for the Beginning Farmer Option, the applicant must meet basic TAEP eligibility requirements (p. 6) unless otherwise specified below.

- **First time TAEP applicant** — 2023 will be the first year the applicant has applied for TAEP cost share funding.
- **Farming ten years or less** – applicant must be actively involved in the production of row crops and/or livestock at time of application and must have started their farming operation after January 1, 2013.
- **Federal IRS Schedule F (Form 1040) Filing** — applicant must have filed a Federal IRS Schedule F (Form 1040), Profit or Loss from Farming, within the last two years (2021 or 2022) unless the applicant began their operation in 2023. *Applicant may be asked to submit a copy of their Schedule F prior to TAEP approval to verify their farming operation.*
- **Reduced Minimum Requirements** — the program minimum requirements are reduced for applicants qualifying for the TAEP Beginning Farmer Option. Applicant must meet at least one of the minimum livestock/acreage requirements for program applied for.
 - Head of livestock refers to maximum number of single type, regardless of sex or age, at one time during the last 12 months.
 - Goats/Sheep can be combined to meet minimum requirement.

Producer Type	Beginning Farmer Option Eligible Programs	Reduced Minimum Requirements	Certification Required to Apply
Cattle	Genetics or Livestock Equipment	5-29 Head	BQA – cattle producers
Goats/Sheep	Genetics or Livestock Equipment	10-49 Head	None
Row Crop	Row Crop Solutions	25-99 Acres in row crop production (corn, cotton, soybeans, and/or wheat)	None

- **Educational Certification Required** — applicant must complete **UT Farming Fundamentals** or **TSU New Farmer Academy** prior to program reimbursement deadline.
 - Applicant who completes the education requirement will be reimbursed at 50% up to the program maximum. *Standard 35% cost share is not available for the Beginning Farmer Option. If you are unable to complete the UT Farming Fundamentals course or attend the TSU New Farmer Academy, your project will not be funded.*
 - Proof of UT Farming Fundamentals or TSU New Farmer Academy certification is required at time of reimbursement (not at time of application). Certificates issued 2020 or after will be accepted.

Beginning Farmer Option

Eligible Beginning Farmer Option Programs

Genetics – Beginning Farmer Option See pp. 14-19 for eligible items			
Reduced Minimum Requirements*	Certification Required to Apply	Cost Share	Educational Requirement**
Cattle: 5-29 Head Goats/Sheep: 10-49 Head	BQA – Cattle	50%	UT Farming Fundamentals TSU New Farmer Academy

Livestock Equipment – Beginning Farmer Option See pp. 12-13 for eligible items			
Reduced Minimum Requirements*	Certification Required to Apply	Cost Share	Educational Requirement**
Cattle: 5-29 Head Goats/Sheep: 10-49 Head	BQA – Cattle	50%	UT Farming Fundamentals TSU New Farmer Academy

Row Crop Solutions – Beginning Farmer Option See pp. 32-33 for eligible items			
Reduced Minimum Requirements*	Certification Required to Apply	Cost Share	Educational Requirement**
25-99 Acres in row crop production (corn, cotton, soybeans, wheat)	Not Applicable	50%	UT Farming Fundamentals TSU New Farmer Academy

* Applicant must meet at least one minimum program requirement at time of application.

** Approved applicant must complete one educational requirement prior to reimbursement.

Educational Courses for the Beginning Farmer Option

The **UT Farming Fundamentals** educational program will focus on producers who are beginning a new venture in agriculture. The program will include resources and information on the essential principles needed to build a successful operation. The topics will include production basics, farm and financial management, marketing basics, taxes, business plan development, and other industry related issues. For more information, please contact your local UT Extension office or visit utextension.tennessee.edu.

The **TSU Tennessee New Farmer Academy** is a seven-month certificate program designed for those with an interest in becoming agricultural entrepreneurs. The program focuses on teaching the concepts, providing the information, and facilitating the hands-on experience needed to build solid, viable, and successful agricultural businesses. In addition to classroom instruction, the New Farmer Academy provides hands-on experiential sessions on a variety of topics. For more information, please visit www.tnstate.edu/extension or contact Finis Stribling, III, Area Extension Specialist, (931) 375-5301, fstribling@tnstate.edu.

Livestock Equipment

Minimum Requirements*	Certification Required to Apply	Beginning Farmer Option**	\$2,000 Maximum Reimbursement	
Cattle — 30 Head Goats/Sheep — 50 Head	BQA — Beef and Dairy	Available – see pp. 10-11	Standard 35% Cost Share	Master 50% Cost Share
Head of livestock = maximum number of single type, regardless of sex or age, at any one time during the last 12 months. *Applicant must meet at least one minimum program requirement at time of application. **This program is available for individuals qualifying for the Beginning Farmer Option. Goats/Sheep can be combined to meet minimum head requirement.				

Guidelines

Allowable purchase dates for Livestock Equipment are from October 1, 2023 – April 1, 2024.

All items, regardless of backorder status, must be purchased (paid in full or financed) by the program reimbursement deadline. Backordered items may be ineligible for cost share if not delivered to the farm by the program deadline. *See p. 7 for more information regarding program requirements.*

Eligible Items

New Equipment Only

- ∅ New items cannot be previously owned.
- ∅ Items purchased at an auction are considered used and are not eligible.
- ∅ Replacement parts are not eligible.

Handling

1. Alley frame
2. Alleyway
3. Animal scale/indicator
4. Continuous pipe panel (10) — **minimum purchase of ten (10)**; must be installed at the time of reimbursement
5. Corral panel (10) — **minimum purchase of ten (10)**; portable panel, gate in frame/bow gate
6. Crowding/sweep tub
7. Head gate
8. Livestock trailer — min. 16 ft; at least one cut gate; must be titled in the applicant's name at time of reimbursement
9. Loading chute for semi-trailer
10. Palpation cage
11. Pasture gate — **min. 8 ft; heavy duty**; must be installed at time of reimbursement
12. Rolling block door/alley back stop
13. Sheep wool shear — min. 3 in. wide head, min. 2,000 RPM
14. Sheep/goat fitting stand
15. Squeeze chute — carriage optional at time of purchase only
16. Tilt/roll table or hoof trimming table/chute
17. Ultrasound — accessories are optional and eligible only if purchased along with ultrasound

Eligible Items

Feeding

18. Automatic cube pellet feeder/cake feeder — scales optional at time of purchase only
19. Concrete bunk feeder (3) — **minimum purchase of three (3)**
20. Creep feeder — creep pen optional at time of purchase only
21. Feed bin — gravity or auger flow only
22. Feeder panel (3) — **minimum purchase of three (3)**
23. Hay unroller
24. Self-unloading inline hay trailer
25. Sheep/goat automatic milk feeding machine
26. Slant bar hay feeding wagon

Pasture

27. GPS — display and/or receiver only
28. Pasture drag/harrow — commercially manufactured
29. Pasture sprayer — **200 gal. min.** tank capacity; PTO, shaft, or hydraulic drive
30. Wick applicator/wiper — tractor/ATV attachment/mounted only

Minimum Purchase Required

The following items require a minimum number of items to be purchased to qualify for cost share reimbursement.

- Item#4: Continuous pipe panel (10) — **minimum purchase of ten (10)**
- Item#5: Corral panel (10) — **minimum purchase of ten (10)**
- Item#19: Concrete bunk feeder (3) — **minimum purchase of three (3)**
- Item#22: Feeder panel (3) — **minimum purchase of three (3)**

Genetics Overview

\$2,000 Maximum Reimbursement

- Reimbursements will be based on maximum allowed per eligible item
- All items below can be combined for a maximum reimbursement of \$2,000
- Standard 35% cost share or Master 50% cost share

Item	Maximum Per Item*
Bred Does/Ewes	\$200
Bucks/Rams	\$500
Bred Beef Heifers	\$500
Bulls — true NCE EPDs per breed list	\$1,000
Bulls – Genomic Enhanced EPDs (GE-EPD) per breed list	\$2,000
Artificial Insemination	\$2,000

* Items purchased must meet specified conditions to be eligible for the maximum.

TAEP Bull Purchase Reimbursement Tool

The TAEP Bull Reimbursement Tool is an online aid to help in determining a bull's EPD, Index, Accuracy, Genomic & Pedigree Print Date qualification and potential TAEP reimbursement amount. This public service is provided by the UT Department of Animal Science and TAEP. This online tool is found on the **TAEP home webpage** (www.tn.gov/taep).

This tool is intended to be used as a guide to provide information based solely on pedigree data entered by the user. This tool is provided without any guarantees of acceptance. Pedigree must be submitted with reimbursement request and include GE-EPDs (or EPDs with 0.15 accuracies with breeds that do not offer GE-EPDs), indexes, accuracies, genomic verification (if applicable), and have a printed date between October 1, 2023 and the date of purchase.

In addition to a bull meeting EPD, Index, Accuracy, Genomic & Pedigree Print Date qualifications, the bull must also have an eligible BSE, 840 EID tag, and negative test result for BVD-PI.

Genetics and Herd Health Glossary

840 EID	Official USDA Electronic 15 digit ID beginning with "840"	Lepto HB	Leptospira Hardjo-Bovis
Acc	EPD Accuracy (0 – 1.0)	Lepto	Leptospirosis
AI	Artificial Insemination	LNM	Lifetime Net Merit
BRSV	Bovine Respiratory Syncytial Virus	NCE	National Cattle Evaluation
BSE	Breeding Soundness Evaluation	NN	Spider free results from the Spider Syndrome Genotype test
BVD	Bovine Viral Diarrhea Virus	PI	Production Index — Dairy (ex. TPI for Holstein/JPI for Jersey)
BVD-PI	Bovine Viral Diarrhea Virus Persistent Infection	PI₃	Bovine Parainfluenza Type 3 Virus
CE	Calving Ease Direct EPD (Calving Ease group)	RR	Scrapie free results from the Scrapie Codon 171 Genotype test
CVI	Certificate of Veterinary Inspection	Trich	Trichomoniasis
EPD	Expected Progeny Difference	WW	Weaning Weight EPD (Growth group)
GE-EPD	Genomic Enhanced — Expected Progeny Difference	YW	Yearling Weight EPD (Growth group)
IBR	Infectious Bovine Rhinotracheitis		

Trichomoniasis ("Trich") is a venereal disease of cattle caused by the protozoan *Tritrichomonas foetus*, which is transmitted from cow to cow by infected bulls. **This disease reduces calf production by decreasing fertility and inducing abortions.** While heifers usually rid themselves of Trichomoniasis in three to six months, bulls carry the infection for life without showing any symptoms. With no medically approved cures available, detection and control of infected bulls is key to containing the disease. An official sample must be collected by an accredited veterinarian who has been approved by the state. *Trichomoniasis testing is recommended during BSE exam along with submitting ear notch sample for BVD-PI test and securing 840 EID tag for bull.*

Trichomoniasis testing is highly recommended for non-virgin bulls during the BSE exam, 840 EID tag, and BVD-PI testing. All bulls purchased from out of state sources must meet import requirements as set forth by the State Veterinarian's Office.

Genetics – Bred Beef Heifers

Minimum Requirements*	Certification Required to Apply	Beginning Farmer Option**	\$2,000 Maximum Reimbursement
Cattle — 30 Head	BQA — Beef	Available – see pp. 10-11	\$500 maximum per heifer
Head of livestock = maximum number of single type, regardless of sex or age, at any one time during the last 12 months. *Applicant must meet at least one minimum program requirement at time of application. **This program is available for individuals qualifying for the Beginning Farmer Option.			

Guidelines

Buyer must communicate with the seller prior to purchasing to ensure the bred beef heifer meets all TAEP eligibility requirements. Bred beef heifers that do not meet all eligibility requirements between October 1, 2023 and **date of purchase** will be denied cost share reimbursement.

Eligible Items

1. Bred Beef Heifers - \$500 maximum per heifer

Qualifications

1. Stewardship Information (Producer Affidavit required)
 - a. Official USDA permanent identification — heifers must be individually and permanently identified with 840 EID, metal tag, breed registry brand or tattoo
 - b. Ownership — seller name, address, and phone number
 - c. Sale Information — price and sale date
 - d. Age — maximum of 28 months at time of purchase
 - e. Service Sire (AI or natural) — heifers must be bred to a bull that meets or exceeds the Calving Ease Direct (CED) Genomic Enhanced EPD (GE-EPD) from the TAEP Calving Ease bull type requirements. AI bred to a high accuracy calving ease sire is recommended. *See p. 17 for information about TAEP EPD bull requirements.*
2. Preventative Health (Producer Affidavit required)

Must be vaccinated with two rounds of the following vaccines:

 - a. Respiratory: IBR, BVD, PI₃, BRSV. *Recommended — fetal protection (FP)*
 - b. Blackleg: 7-way Clostridial
 - c. Reproductive: Lepto. *Recommended — Lepto HB*
3. Current and Reproductive Health (Veterinarian Affidavit required)
 - a. Official USDA permanent identification
 - b. Veterinarian name, clinic, and phone number
 - c. Test negative for BVD-PI; *lab results required*
 - d. Size – heifer must be a minimum of 800 pounds at pregnancy exam
 - e. Pregnancy status – list date of pregnancy exam and days pregnant
 - Heifer must be a minimum of 90 days bred at date of purchase
 - March 1, 2024 is the latest breeding date that 90-day pregnancy could be verified by a June 1, 2024 sale date (June 1, 2024 reimbursement deadline)
 - Heifers already nursing first (1st) calf at time of purchase must submit a Veterinarian Affidavit verifying current health status of both heifer & calf

Requirements

1. Producer Affidavit — attach pedigree(s) with GE-EPDs and pedigree print date for service sires
2. Veterinarian Affidavit — attach negative BVD-PI test results

Affidavit forms are available at www.tn.gov/taep in Producer Programs under Genetics, from Tennessee licensed veterinarians, and included in the TAEP Genetics reimbursement packet. Affidavits allow up to four (4) heifers with consistent management and breeding to be listed on each form. List all IDs, birth date range, and range of days pregnant.

Genetics – Cattle

Minimum Requirements*	Certification Required to Apply	Beginning Farmer Option**	\$2,000 Maximum Reimbursement <i>See p. 14 for item maximums</i>	
Cattle — 30 Head	BQA — Beef and Dairy	Available – see pp. 10-11	Standard 35% Cost Share	Master 50% Cost Share
Head of livestock = maximum number of single type, regardless of sex or age, at any one time during the last 12 months. *Applicant must meet at least one minimum program requirement at time of application. **This program is available for individuals qualifying for the Beginning Farmer Option.				

Guidelines

Buyer must communicate with the seller prior to purchasing to ensure the bull meets all TAEP eligibility requirements. Bulls that do not meet all eligibility requirements between October 1, 2023 and **date of purchase** will be denied cost share reimbursement.

Eligible Items

- Bulls
 - Breeds with Genomic Enhanced EPDs (GE-EPD) – eligible GE-EPDs required for cost share reimbursement up to \$2,000.
 - Breeds that do not offer Genomic Enhanced EPDs – eligible true NCE EPDs with minimum 0.15 accuracies required for cost share reimbursement up to \$1,000.
- AI — semen from eligible AI sires – 5 sires maximum (qualification proof required: EPD/Index – Beef; LNM/PI - Dairy), new semen tanks, liquid nitrogen fills, synchronization cost, AI supplies & equipment, AI technician fees, and/or AI training certification
- Bred beef heifers — see p. 15

Requirements – Bulls

- BVD-PI — test negative for BVD-PI; *lab results required; ear notch samples must be submitted if using TDA Kord Lab*
- 840 EID — “840” are the first three digits — available from veterinarian at time of BSE, BVD-PI, and Trichomoniasis testing
- BSE — performed by licensed veterinarian within 90 days of purchase; *Trichomoniasis testing recommended*
- Dairy — bulls and semen must meet or exceed the minimum LNM or PI requirements; *AI sires are recommended*
- Beef — bulls and semen must meet or exceed EPD/Index requirements in each of the two (2) EPD/Index groups (Calving Ease + Index or Growth) for one of the three bull types: Calving Ease/Maternal, Balanced Trait/Maternal, or End Product/Terminal.

IMPORTANT – New for 2023-2024

- Breeds offering Genomic Enhanced EPDs (GE-EPD) must have eligible GE-EPDs between October 1, 2023 and **date of purchase** to be eligible for cost share reimbursement.

Breeds with GE-EPDs: Angus, Beefmaster, Black Hereford, Brahman, Brangus (Black, Red & Ultrablack), Braunvieh, Charolais, Gelbvieh & Balancer, Hereford, Limousin & Lim-Flex, Red Angus, Santa Gertrudis, Shorthorn, Simmental & Hybrid

- Breeds that do not offer Genomic Enhanced EPDs (GE-EPD) must have eligible true NCE EPDs with minimum 0.15 accuracies between October 1, 2023 and **date of purchase** to be eligible for cost share reimbursement.

Breeds with true NCE EPDs with minimum 0.15 accuracies: Akaushi, Chiangus, Maine-Anjou & MaineTainer, Murray Grey, Salers, Senepol, South Devon, Wagyu

EPD, Genomic, Index, Accuracy, and Pedigree Print Date Information

Eligible beef breeds for the TAEP Genetics program must have a national breed performance testing program that participates in a National Cattle Evaluation (NCE) program recognized by the Beef Improvement Federation. Genomic Enhanced or true NCE EPDs must be calculated and printed from the most prominent breed association.

TAEP 2023-2024 EPD, Genomic, Index, Accuracy, & Pedigree Print Date Requirements will be posted in September 2023 at www.tn.gov/taep in Producer Programs under Genetics and will be included in the reimbursement packet.

\$2,000 Maximum Reimbursement — Bulls must have eligible **Genomic Enhanced EPDs (GE-EPD) and Indexes** on breed association pedigree between October 1, 2023 & **date of purchase** and meet TAEP EPD/Index requirements for one of the three eligible bull types to be eligible for cost share reimbursement.

- **Breeds with GE-EPDs:**
 - Angus
 - Beefmaster
 - Black Hereford
 - Brahman
 - Brangus (Black, Red & Ultrablack)
 - Braunvieh
 - Charolais
 - Gelbvieh & Balancer
 - Hereford
 - Limousin & Lim-Flex
 - Red Angus
 - Santa Gertrudis
 - Shorthorn
 - Simmental & Hybrid
- Breed association pedigree must be submitted with reimbursement request and include eligible GE-EPDs, Indexes, accuracies, genomic status, and have a printed date between October 1, 2023 and **date of purchase**.
- Reimbursement will be calculated based on purchase price at either 35% or 50% up to \$2,000 maximum.
- Payment for these breeds will be denied if individual bulls do not have eligible Genomic Enhanced EPDs (GE-EPD) & Indexes calculated by their breed association between October 1, 2023 and **date of purchase**.

\$1,000 Maximum Reimbursement — Bulls must have eligible **true NCE EPDs with minimum 0.15 accuracies** on breed association pedigree between October 1, 2023 & **date of purchase** and meet TAEP EPD requirements for one of the three eligible bull types to be eligible for cost share reimbursement. These EPDs must meet or exceed minimum TAEP EPD requirements. *Interim EPDs, pedigree estimates, pedigree index (ex. I, I+, P, P+, or 0.05 Accuracy), or parental averages are not eligible for reimbursement.*

- **Breeds with true NCE EPDs:**
 - Akaushi
 - Chiangus
 - Maine-Anjou & MaineTainer
 - Murray Grey
 - Salers
 - Senepol
 - South Devon
 - Wagyu
- Breed association pedigree must be submitted with reimbursement request and include eligible EPDs, accuracies, and have a printed date between October 1, 2023 and **date of purchase**.
- Reimbursement will be calculated based on purchase price at either 35% or 50% up to \$1,000 maximum.
- Payment for these breeds will be denied if individual bulls do not have eligible true NCE EPDs with minimum 0.15 accuracies calculated by their breed association between October 1, 2023 and **date of purchase**.

Bull Type Options

Bulls and semen must meet or exceed EPD/Index requirements in each of the two (2) EPD/Index groups (Calving Ease + Index or Growth) for one of the following three bull types:

- Calving Ease/Maternal — must meet **CED + (Maternal Index or WW or YW)**
- Balanced Trait/Maternal — must meet **CED + (Maternal Index or WW or YW)**
- End Product/Terminal — must meet **CED + (Terminal Index or WW or YW)**

Genetics – Goats/Sheep

Minimum Requirements*	Certification Required to Apply	Beginning Farmer Option**	\$2,000 Maximum Reimbursement <i>See p. 14 for item maximums</i>	
Goats/Sheep — 50 Head	Not applicable	Available – see pp. 10-11	Standard 35% Cost Share	Master 50% Cost Share
Head of livestock = maximum number of single type, regardless of sex or age, at any one time during the last 12 months. *Applicant must meet at least one minimum program requirement at time of application. **This program is available for individuals qualifying for the Beginning Farmer Option. Goats/Sheep can be combined to meet minimum head requirement.				

Guidelines

Buyer must communicate with the seller prior to purchasing to ensure the goat/sheep meets all TAEP eligibility requirements. Goats/sheep that do not meet all eligibility requirements between October 1, 2023 and **date of purchase** will be denied cost share reimbursement.

Eligible Items — Goats

- Bucks (pedigree required*) - \$500 maximum per buck
- Bred Does - \$200 per doe – see p. 19
- AI
 - Buck semen (pedigree required*) – *AI qualified bucks with semen code is suggested*
 - New semen tanks, liquid nitrogen fills, synchronization cost, AI supplies & equipment
 - AI technician fees and/or AI training certification
- Breeding soundness evaluation (BSE), physical examination, or pregnancy exam – by Tennessee licensed veterinarian

Eligible Items — Sheep

- Rams (pedigree required*) - \$500 maximum per ram
 - RR results for the Scrapie Codon 171 Genotype test
 - NN results for the Spider Syndrome Genotype test
- Bred Ewes- \$200 per ewe – see p. 19
- AI
 - Ram semen (pedigree required*) – *AI qualified rams with semen code is suggested*
 - New semen tanks, liquid nitrogen fills, synchronization cost, AI supplies & equipment
 - AI technician fees and/or AI training certification
- Breeding soundness evaluation (BSE), physical examination, or pregnancy exam – by Tennessee licensed veterinarian
- Genomic testing – Scrapie, Spider, dwarfism

Requirements — Bucks and Rams

- Physical Examination or BSE – must be performed by a licensed veterinarian within 90 days of purchase or reimbursement
- Official Identification – Scrapie tag, microchip, or breed registry identification
- Pedigree
 - Bucks (pedigree required*)
 - Rams (pedigree required*)
 - * *Breed registration certificate or herd management software pedigree (ex. HerdBoss) suggested. Examples and helpful information are available at <https://animalscience.tennessee.edu/small-ruminants/>*
- Genotype test results – Rams must test negative for Scrapie and Spider genes

Genetics – Bred Does/Ewes

Minimum Requirements*	Certification Required to Apply	Beginning Farmer Option**	\$2,000 Maximum Reimbursement <i>See p. 14 for item maximums</i>	
Goats/Sheep — 50 Head	Not applicable	Available – see pp. 10-11	Standard 35% Cost Share	Master 50% Cost Share
Head of livestock = maximum number of single type, regardless of sex or age, at any one time during the last 12 months. *Applicant must meet at least one minimum program requirement at time of application. **This program is available for individuals qualifying for the Beginning Farmer Option. Goats/Sheep can be combined to meet minimum head requirement.				

Guidelines

Buyer must communicate with the seller prior to purchasing to ensure the bred doe/ewe meets all TAEP eligibility requirements. Does/ewes that do not meet all eligibility requirements between October 1, 2023 and **date of purchase** will be denied cost share reimbursement.

Eligible Items

1. Bred Does/Ewes - \$200 per doe or ewe

Qualifications

1. Stewardship Information (Producer Affidavit required)
 - a. Official USDA permanent identification — must be individually and permanently identified with Scrapie tag, microchip, or breed registry identification
 - b. Ownership — seller name, address, and phone number
 - c. Sale information — price and sale date
 - d. Age — maximum of 24 months at time of purchase
 - e. Service Sire (AI or natural) — buck or ram
 - AI service sire — attach pedigree or semen catalog data
 - Natural service sire — attach pedigree
 - Buck (pedigree required)
 - Ram (RR & NN genotype results and pedigree required)
2. Preventative Health (Producer Affidavit required)
 - a. Dewormed — required
 - Ewes — RR & NN genotype results and pedigree suggested*
 - Flock health program with local veterinarian is suggested*
3. Current and Reproductive Health (Veterinarian Affidavit required)
 - a. Official USDA permanent identification — must be individually and permanently identified with Scrapie tag, microchip, or breed registry identification
 - b. Veterinarian name, clinic, and phone number
 - c. Pregnancy status – minimum of 45 days bred at date of purchase

Requirements

1. Producer Affidavit — attach pedigree(s) or semen catalog data
2. Veterinarian Affidavit

Affidavit forms are available at www.tn.gov/taep in Producer Programs under Genetics, from Tennessee licensed veterinarians, and included in the TAEP Genetics – Goats & Sheep reimbursement packet. Affidavits allow up to ten (10) bred does/ewes with consistent management and breeding to be listed on each form. List all IDs, birth date range, and range of days pregnant.

Herd Health

Minimum Requirements*	Certification Required to Apply	Beginning Farmer Option**	Lifetime Limit	\$6,000 Maximum Reimbursement
Cattle — 30 Head	BQA — Beef and Dairy	Not Available	Three (3) Reimbursements	Payment amount per head
Head of livestock = maximum number of single type, regardless of sex or age, at any one time during the last 12 months. *Applicant must meet at least one minimum program requirement at time of application. **This program is not available for individuals qualifying for the Beginning Farmer Option. Lifetime Limit = refers to the number of allowed reimbursements.				

Guidelines

This is a record keeping reimbursement. Participants must provide complete data when filling out the reimbursement documentation. Reimbursement is based upon a per head payment instead of a cost share percentage.

This program focuses on improving the whole herd health and reputation of Tennessee cattle by encouraging producers to develop a preventative vaccination protocol for their cattle operation. Prioritizing the health and well-being of your cattle is key to a successful operation. A herd health protocol helps to safeguard against sickness and death within the herd.

This program targets all beef and dairy cattle. This program requires basic preventative vaccinations that focus on respiratory diseases, Blackleg, and breeding health. *Producers are encouraged to work with a Tennessee licensed large animal veterinarian to develop a vaccination protocol for their herd.*

What action is required to participate in this program?

Producers will be required to implement the following TAEP Herd Health Protocol and keep records of vaccinations on each individual animal. Information will include: animal identification, sex of animal, date vaccinated, castrated, and dehorned. In addition, producers will be required to list the name, lot number, and expiration date for each product administered for respiratory diseases, Blackleg, and Lepto.

TAEP Herd Health Protocol – Required

1. Vaccination for respiratory diseases for IBR, BVD, PI₃, and BRSV — *all cattle*
2. Vaccination for Blackleg with a 7 or 8 way Clostridial — *required for cattle under 2 years*
3. Vaccination for Lepto — *breeding stock only*
4. Dehorned — *feeder cattle*
5. Castrated — *consult your veterinarian for tetanus recommendations if banding*

Guidelines

Eligible Items

1. TAEP Herd Health Protocol – required

- a. Vaccination for respiratory diseases for IBR, BVD, PI₃, and BRSV – *all cattle*
- b. Vaccination for Blackleg with a 7 or 8 way Clostridial – *required for cattle under 2 years*
- c. Vaccination for Lepto – *breeding stock only*
- d. Dehorned – *feeder cattle*
- e. Castrated – *consult your veterinarian for tetanus recommendations if banding*

Requirements

- a. Indicate vaccination activity for each individual animal on the TAEP Herd Health Record.
 - i. Animal identification
 - ii. Sex of animal
 - iii. Date vaccinated, castrated, and dehorned
- b. List each vaccination on the TAEP Herd Health Record.
 - i. Product name
 - ii. Lot number/serial number
 - iii. Expiration date

2. Additional Opportunities - optional

- a. 840 EID Tag – tags must be listed on TAEP Herd Health Record
- b. BVD-PI Test – ear notch lab results required
- c. Pregnancy Exam - Palpation/Ultrasound – veterinarian test record/invoice required
- d. Treatment for external and internal parasites – indicate on TAEP Herd Health Record
- e. Respiratory Booster Vaccination – indicate on TAEP Herd Health Record
- f. Breeding Soundness Evaluation (BSE) – BSE form or invoice plus bull id completed by TN licensed large animal veterinarian required
- g. Trichomoniasis Test – lab results required
- h. Genomic Testing – test result and/or invoice plus breed registration # or animal id for non-registered
- i. Herd Health Management Software/Subscription – Must submit printout of software records along with proof of purchase of software/subscription between October 1, 2023 – August 1, 2024

Herd Health Incentives	
Required	\$/head
TAEP Herd Health Protocol	\$15
Optional	\$/head
840 EID Tags	\$2
BVD-PI Test	\$5
Pregnancy Exam — Palpation/Ultrasound	\$5
Treatment for external and internal parasites	\$5
Respiratory Booster Vaccination	\$10
Breeding Soundness Evaluation (BSE)	\$25
Trichomoniasis Test	\$35
Genomic Testing	\$40
Herd Health Management Software/Subscription	\$200 Max.
Must take place between October 1, 2023 – August 1, 2024.	

Producers are encouraged to combine multiple exams in a single veterinarian visit. For example, Trichomoniasis testing is recommended during BSE exam. It is also recommended to submit ear notch sample for BVD-PI test and secure 840 EID tag for bull during BSE exam.

Working Structures & Fence-line Systems

Minimum Requirements*	Certification Required to Apply	Beginning Farmer Option**	\$4,000 Maximum Reimbursement	
Cattle — 30 Head Goats/Sheep — 50 Head	BQA — Beef and Dairy	Not Available	Standard 35% Cost Share	Master 50% Cost Share
Head of livestock = maximum number of single type, regardless of sex or age, at any one time during the last 12 months. *Applicant must meet at least one minimum program requirement at time of application. **This program is not available for individuals qualifying for the Beginning Farmer Option. Goats/Sheep can be combined to meet minimum head requirement.				

Guidelines

Eligible Items

- Permanent Working Cover** — the purpose of this structure is to cover existing livestock working equipment and sorting pens only
 - New structures — permanent structures only
 - Additions to existing structures — permanent structures only; additions consist of adding square footage to an existing barn in the form of a side shed and/or extension in length
- Permanent Working Pen** — for receiving, separating, weaning, or holding livestock prior to working and/or loading
 - New construction only — see pp. 24 & 25 for requirements
- Fence-line Concrete Bunk Feeding System** — allows for feed to be placed within bunk fence-line system as opposed to in-field feeding
 - System must be built within a fence-line and must include minimum purchase of j-style concrete bunk feeder (1), cable/railing, and concrete pad — see pp. 26 & 27
- Fence-line Hay Feeding System** — allows for hay bales to be placed within a fence-line feeding area as opposed to in-field feeding
 - System must be built within a fence-line and must include minimum purchase of feeder panels (3), posts (4), and concrete pad — see pp. 28 & 29

Permanent Working Cover Requirements

- New **permanent** structures or additions to existing structures; *not eligible* — *carport/garage structures*
- Minimum size of 480 sq. ft. and minimum width of 16 ft.
- Minimum eave height — 10 ft. high clearance at the outside of shortest wall
- Minimum of two openings for livestock access/movement
- Roof material — metal or polymer coated fabric
- Sides/walls (optional) — metal or wood; *structure cannot be completely enclosed*
- Labor for construction of Permanent Working Cover; *not eligible* — *labor provided by applicant*
- Structure must cover existing working equipment (alley, crowding system area, and head gate and/or squeeze chute) at time of reimbursement. **Equipment is not eligible for cost share reimbursement.**

Permanent Working Cover Reimbursement

Approvals will be allocated for the maximum amount of \$4,000. Reimbursements will be based on finished project up to **maximum per square foot**. Examples of how to calculate the reimbursement amount are available at www.tn.gov/taep in Producer Programs under Working Structures & Fence-line Systems.

- 35% Cost Share — Standard Producer
\$3.00/sq. ft. maximum reimbursement
Total reimbursement not to exceed \$4,000
- 50% Cost Share — Master Producer
\$4.00/sq. ft. maximum reimbursement
Total reimbursement not to exceed \$4,000

Permanent Working Cover Examples

IMPORTANT REMINDER: Structure must cover existing working equipment (alley, crowding system area, and head gate and/or squeeze chute) at time of reimbursement. **Equipment is not eligible for cost share.**

NEW STRUCTURE TO COVER EXISTING EQUIPMENT

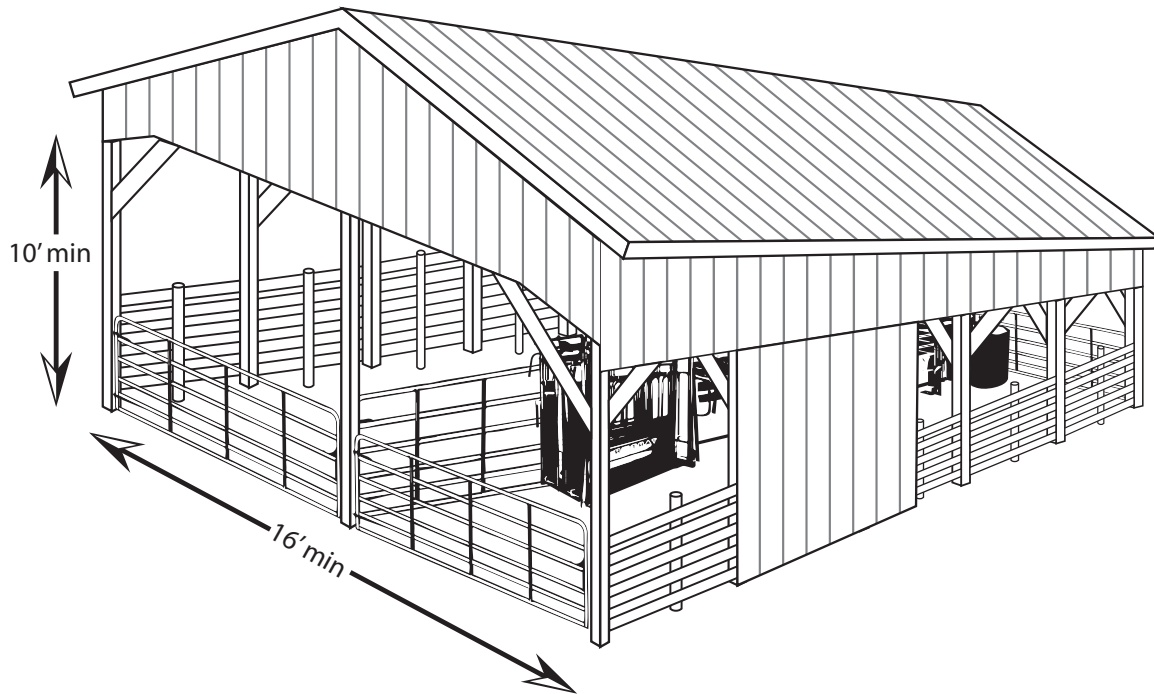

ADDITION TO EXISTING STRUCTURE

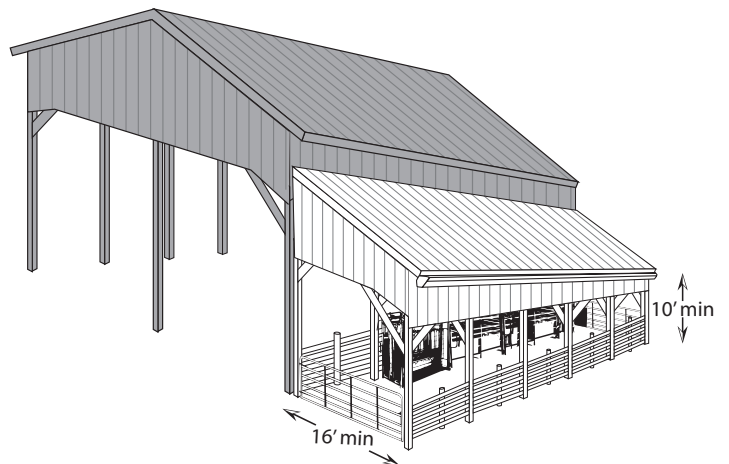

COVERING EXISTING EQUIPMENT

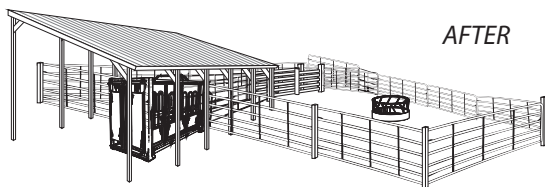
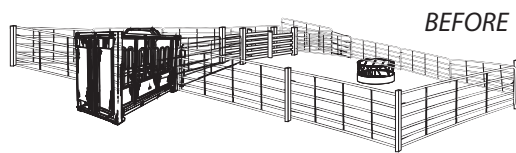

Not all items in these examples are eligible for cost share; not eligible - gates, gutters, livestock equipment, carport/garage structures.

Working Structures & Fence-line Systems ... continued

Minimum Requirements*	Certification Required to Apply	Beginning Farmer Option**	\$4,000 Maximum Reimbursement	
Cattle — 30 Head Goats/Sheep — 50 Head	BQA — Beef and Dairy	Not Available	Standard 35% Cost Share	Master 50% Cost Share
Head of livestock = maximum number of single type, regardless of sex or age, at any one time during the last 12 months. *Applicant must meet at least one minimum program requirement at time of application. **This program is not available for individuals qualifying for the Beginning Farmer Option. Goats/Sheep can be combined to meet minimum head requirement.				

Guidelines - continued from p. 22

Permanent Working Pen Requirements

- New construction only; *not eligible - building pen to an existing fence and/or pen*
- Maximum size — 10,000 sq. ft.
- Minimum size — 420 sq. ft.
- Rails — minimum of (4) lumber/pipe rails or (3) guardrails; *not eligible — portable corral/wire panels*
- Multiple pens are allowed
- Eligible materials include:
 - Treated lumber
 - Boards (minimum 2 in. x 6 in.)
 - Wood posts (minimum 6 in.)
 - Metal
 - Guard rail
 - I-beams
 - Pipe
 - Continuous pipe panels (minimum 16 gauge); *not eligible — portable corral/wire panels*
 - Pipe posts
 - Gates
 - Minimum 2 in. — 16 gauge tubes
 - Minimum length 8 ft.
 - Must be installed at time of reimbursement
- Labor for construction of Permanent Working Pen; *not eligible — labor provided by applicant*
 - Labor cannot exceed 30% of total reimbursement; labor must be itemized on invoice

Permanent Working Pen Reimbursement

- Reimbursements will be based upon eligible purchase.
- Reimbursement for contracted labor cannot exceed 30% of total reimbursement.
- Material and labor costs must be itemized on invoice.

Permanent Working Pen Examples

IMPORTANT REMINDER: Eligible materials and pen requirements are listed on p. 24. Pens built from existing pens and/or fences are not eligible for cost share. **Equipment is not eligible for cost share.**

Multiple pen with guardrail - minimum (3) rails

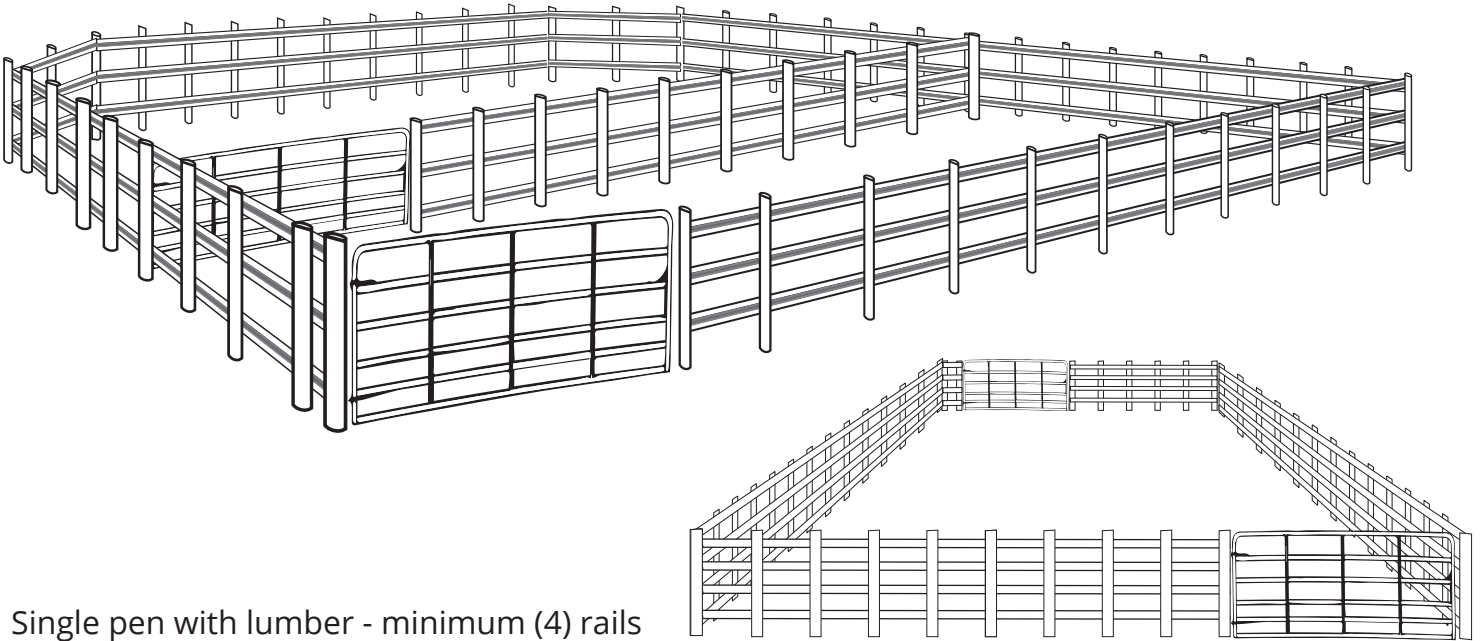

Single pen with lumber - minimum (4) rails

Gates must be installed at time of reimbursement; not eligible - equipment, building from existing pens and/or fences, wire panels, and portable corral panels.

Not eligible - portable corral panels

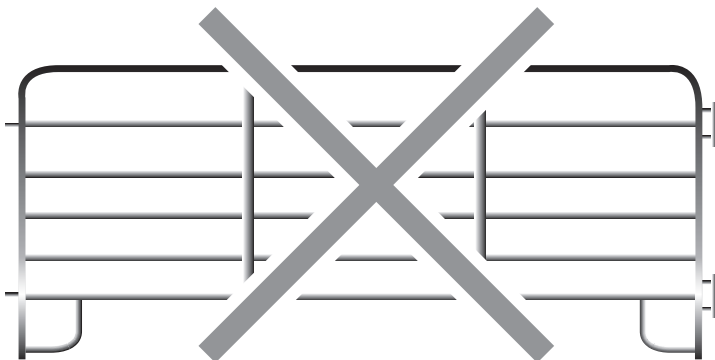

Not eligible - wire panels

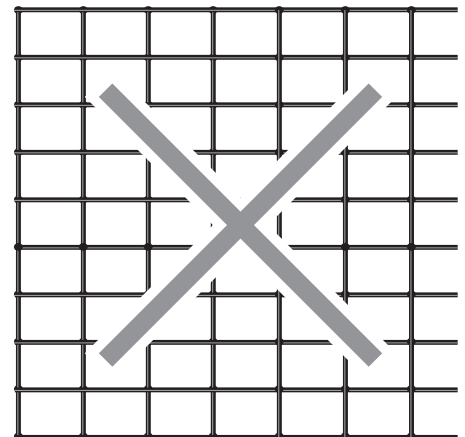

Working Structures & Fence-line Systems ... continued

Minimum Requirements*	Certification Required to Apply	Beginning Farmer Option**	\$4,000 Maximum Reimbursement	
Cattle — 30 Head Goats/Sheep — 50 Head	BQA — Beef and Dairy	Not Available	Standard 35% Cost Share	Master 50% Cost Share
Head of livestock = maximum number of single type, regardless of sex or age, at any one time during the last 12 months. *Applicant must meet at least one minimum program requirement at time of application. **This program is not available for individuals qualifying for the Beginning Farmer Option. Goats/Sheep can be combined to meet minimum head requirement.				

Guidelines - continued from p. 24

Fence-line Concrete Bunk Feeding System Requirements

This system allows feed to be placed within concrete bunks located along an existing **fence-line** that is easily accessed from a road or farm lot as opposed to in-field feeding. Eligible items include j-style concrete bunks, cable/railing, and concrete pad.

- System setup must include minimum **purchase** of:
 - J-style concrete bunk feeder - *new equipment only*
 - Cable/railing - *must extend the length of the system*
 - Concrete pad - *see p. 27 for dimensions*
- System must be built within a **fence-line** (new or existing) with access from a road or a farm lot.
- ∅ Cover/roof, fencing, geotextile, gravel, roads, site prep, and standalone feeding pads are not eligible for cost share reimbursement.

Fence-line Concrete Bunk Feeding System Reimbursement

- Reimbursements will be based upon eligible purchase.
- Reimbursement for contracted labor cannot exceed 30% of total reimbursement.
- Material and labor costs must be itemized on invoice.

Fence-line Concrete Bunk Feeding System Example

Minimum specifications for the fence-line concrete bunk feeding system examples can be found on p. 26.

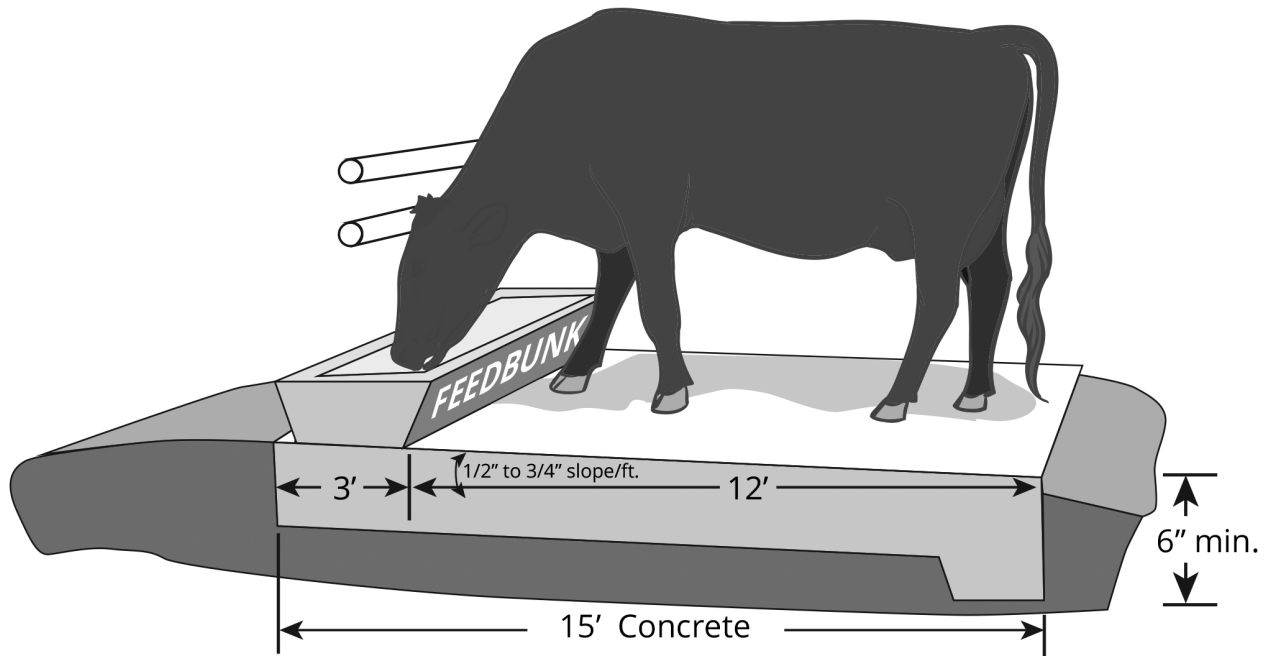

System must be built within **fence-line** (new or existing) with access from a road or a farm lot.

System setup must include purchase of:

- J-style bunk feeders
- Cable/railing
- Concrete pad

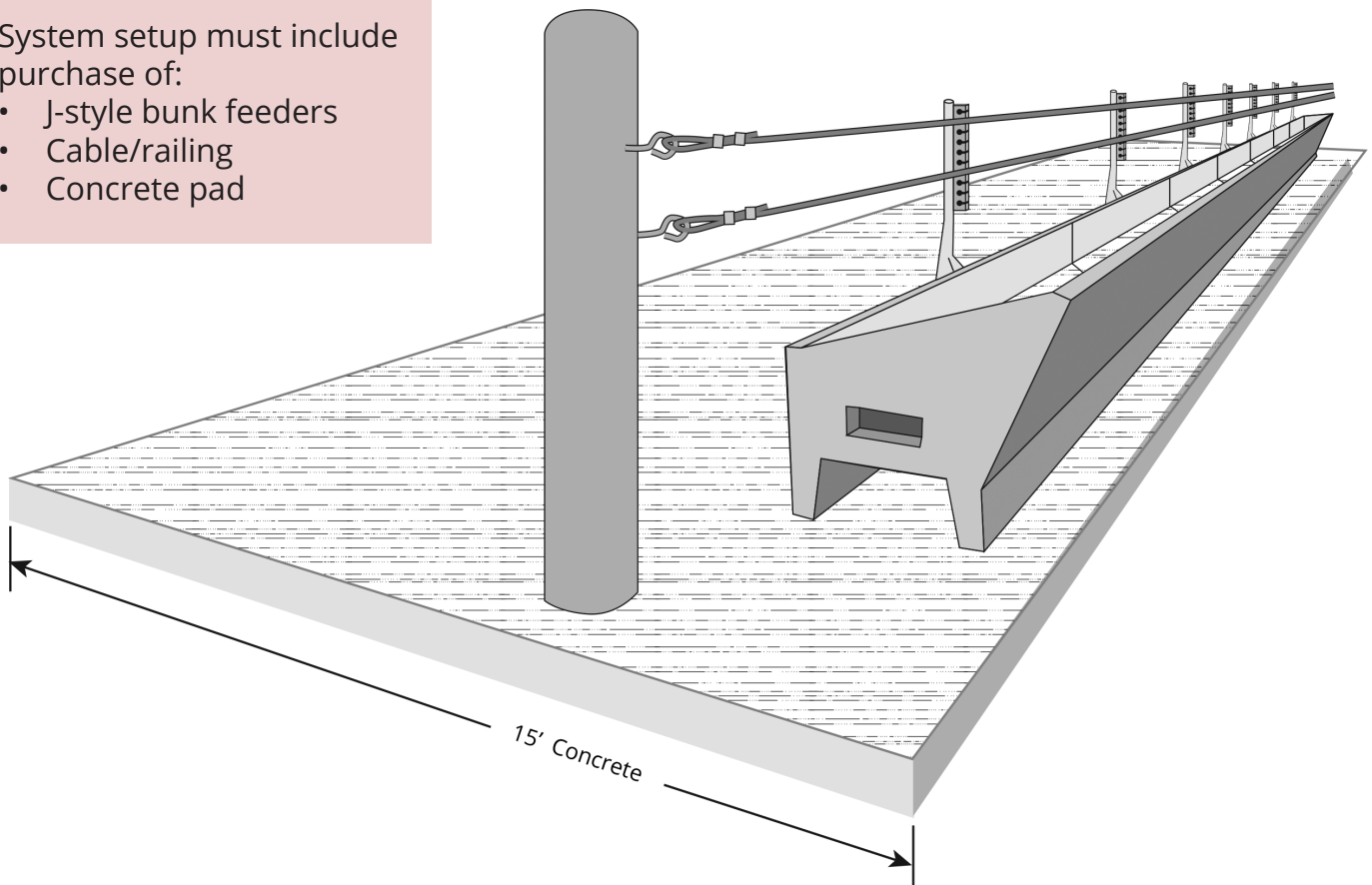

Working Structures & Fence-line Systems ... continued

Minimum Requirements*	Certification Required to Apply	Beginning Farmer Option**	\$4,000 Maximum Reimbursement	
Cattle — 30 Head Goats/Sheep — 50 Head	BQA — Beef and Dairy	Not Available	Standard 35% Cost Share	Master 50% Cost Share
Head of livestock = maximum number of single type, regardless of sex or age, at any one time during the last 12 months. *Applicant must meet at least one minimum program requirement at time of application. **This program is not available for individuals qualifying for the Beginning Farmer Option. Goats/Sheep can be combined to meet minimum head requirement.				

Guidelines - continued from p. 24

Fence-line Hay Feeding System Requirements

This system allows hay bales to be placed within a feeding area located along an existing **fence-line** that is easily accessed from a road or farm lot as opposed to in-field feeding. Eligible items include concrete pad, feeder panels, gate, and posts.

System setup must include minimum **purchase** of:

- (3) Feeder panels - *new panels only*
- (4) Posts - 6" x 6"
- (1) Concrete pad - 30' x 30'
- (1) Gate - *optional*

- System must be built within **fence-line** (new or existing) with access from a road or a farm lot.

∅ Cover/roof, fencing, geotextile, gravel, roads, site prep, and standalone feeding pads are not eligible for cost share reimbursement.

Fence-line Hay Feeding System Reimbursement

- Reimbursements will be based upon eligible purchase.
- Reimbursement for contracted labor cannot exceed 30% of total reimbursement.
- Material and labor costs must be itemized on invoice.

Fence-line Hay Feeding System Example

Minimum specifications for the fence-line concrete hay feeding system examples can be found on p. 28.

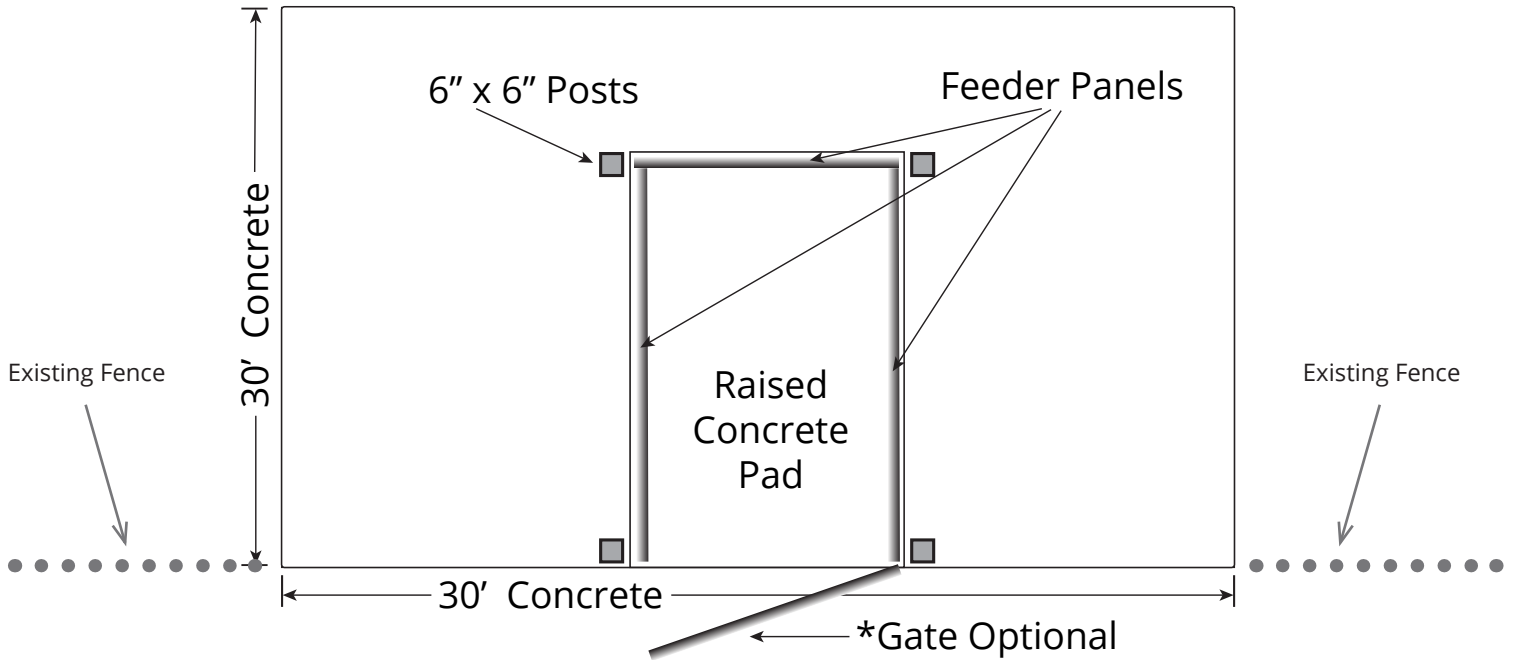

System setup must include minimum purchase of:

- Feeder panels (3)
- Posts (4)
- Concrete pad

System must be built within **fence-line** (new or existing) with access from a road or a farm lot.

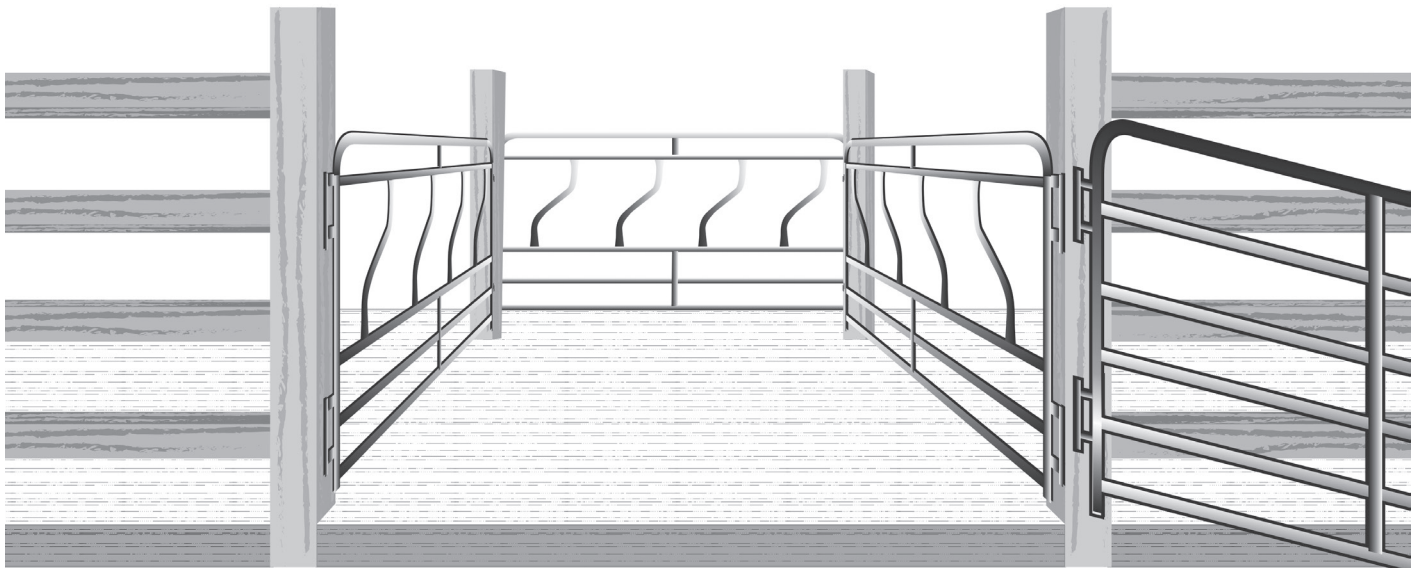

Dairy Solutions

Minimum Requirements*	Certification Required to Apply	Beginning Farmer Option**	\$10,000 Maximum Reimbursement	
Cattle — 30 Head Goats/Sheep — 50 Head	BQA — Cattle Dairy Permit	Not Available	Standard 35% Cost Share	Master 50% Cost Share
Head of livestock = maximum number of single type, regardless of sex or age, at any one time during the last 12 months. *Applicant must meet at least one minimum program requirement at time of application. **This program is not available for individuals qualifying for the Beginning Farmer Option.				

Guidelines

Allowable purchase dates for Dairy Solutions are from October 1, 2023 – August 1, 2024.

All items, regardless of backorder status, must be purchased (paid in full or financed) by the program reimbursement deadline. Backordered items may be ineligible for cost share if not delivered to the farm by the program deadline. *See p. 7 for more information regarding program requirements.*

Dairy Permit Required

- Dairy producers must be permitted by TDA to be eligible as a dairy at time of application.
- Only one person from the farm operation may apply for cost share.
- Contact TDA Consumer and Industry Services Division for dairy permit information at 615-837-5536.

Eligible Items

New Equipment Only — Items 1 - 14

∅ *New items cannot be previously owned.*

∅ *Items purchased at an auction are considered used and are not eligible.*

∅ *Replacement parts are not eligible.*

1. Automatic robotic milking systems
2. Commercial water heater
3. Generator for dairy barn
4. Industrial fans – metal only, minimum size of 36 in.
5. Manure/lagoon agitator
6. Manure/lagoon pump
7. Milk pipeline system – includes, but not limited to automatic washer/sanitizing unit, clean in-place unit, automatic milk take-offs, milk claws, vertical wash vat, milk meters and monitoring system
8. Milk vacuum pump
9. Plate exchange for heating water or cooling milk
10. Secondary bases for concrete free stalls – includes cow mattresses, gel mats, and water beds designed for cow comfort;
not eligible – rubber mats
11. Stationary milk tank
12. UV or filtration system – installation of systems for well water that is required to be tested
13. Vacuum system gauges and regulators
14. Water sterilization equipment

Eligible Items

Testing & Services

15. Activity monitor for identifying cows in heat
16. Milk culture, culture sensitivity test
17. Milking equipment service contract
18. Milk quality lab analyses
19. On-farm antibiotic and mastitis testing – cow-side tests including test kits, subclinical mastitis detectors, and incubator or heater block
20. Somatic cell count test
21. Travel/labor for milk tester (when applicable)

Infrastructure

22. New construction – milking parlor and/or tank room

Master Dairy Program

The Tennessee Master Dairy Program is an educational program that provides a variety of information on animal housing, management, nutrition, reproduction, milk quality, health, handling, welfare, and other topics. Modules are continuously created to provide dairy producers and other interested parties with the most up-to-date information on the topic of interest. At least 3 modules are provided each year across the state to provide dairy producers with easy access to continuing education. Producers interested in becoming a certified Master Dairy Producer will need to receive 6 hours of continuing education credits.

To learn more information and to see upcoming classes, visit <https://tiny.utk.edu/MasterDairy>.

For questions about the program, contact Dr. Liz Eckelkamp (eeckelka@utk.edu or 865-974-8167).

Row Crop Solutions

Minimum Requirements*	Certification Required to Apply	Beginning Farmer Option**	\$12,000 Maximum Reimbursement	
100 Acres in row crop production	Not Applicable	Available – see pp. 10 & 11	Standard 35% Cost Share	Master 50% Cost Share
Corn, Cotton, Soybeans, and/or Wheat only.				
*Applicant must meet at least one minimum program requirement at time of application.				
**This program is available for individuals qualifying for the Beginning Farmer Option.				

Guidelines

Allowable purchase dates for Row Crop Solutions are from October 1, 2023 – August 1, 2024.

All items, regardless of backorder status, must be purchased (paid in full or financed) by the program reimbursement deadline. Backordered items may be ineligible for cost share if not delivered to the farm by the program deadline. *See p. 7 for more information regarding program requirements.*

Eligible Items

New Equipment Only — Items 1 - 13

∅ *New items cannot be previously owned.*

∅ *Items purchased at an auction are considered used and are not eligible.*

∅ *Replacement parts are not eligible.*

1. Bin unload auger/bin sweep
2. Conveyor/grain leg/drive-over pit
3. Cotton round bale handler — must be designated for cotton use only
4. Drive-over scale — scale platform and scale indicator/monitor
5. Drying equipment
6. GPS - display and satellite receiver only; *not eligible - subscriptions*
7. Grain bin — minimum capacity of 10,000 bushels
 - Smaller capacity bins can be combined to reach 10,000 bushel minimum
 - Labor for the construction of bins; *not eligible — labor provided by applicant*
8. Grain bin rescue tube
9. Moisture monitor
10. Overhead loadout bin — minimum capacity of 24 tons
11. Portable bagging system — in-field storage of grain
12. Seed tender trailer — bulk seed delivery system to fill drills/planters; *not eligible - gravity wagon*
13. Stationary fuel/DEF tank and/or fuel tank containment systems — on farm; above ground only; must meet all regulatory requirements

Eligible Items

New or Used — Items 14 - 16

14. Grain vacuum
15. No-till drill — minimum 15 ft. working width, 7.5 in. row space; *not eligible - planters*
16. Transport auger — portable transport auger/conveyor; minimum 20 ft. length

Used equipment must meet all of the following criteria:

- ✓ **Less than 10 years old**
- ✓ **Excellent working condition**
- ✓ **Minimal rust**
- ✓ **Reasonable market price**

Tennessee Department of Agriculture may verify used equipment prior to payment.

Receipt Reminders

- **Receipts must be in the name of the applicant approved for cost share funding.**
- Receipts must also include:
 - Vendor name, address, phone number
 - Description of expense (make, model, serial #, if available)
 - Amount of purchase
 - Date of purchase
- **Quotes and purchase orders do not represent a purchase and are not considered receipts.**
 - Ask for a sales receipt if you are given a quote or purchase order.
 - It may take additional time for the sales representative to secure a sales receipt.
- **Proof of payment may be requested to verify purchase.**

Hay Equipment

Minimum Requirements*	Certification Required to Apply	Beginning Farmer Option**	\$6,000 Maximum Reimbursement	
Cattle — 100 Head Goats/Sheep — 150 Head Hay — 100 Acres in production	BQA — Beef and Dairy	Not Available	Standard 35% Cost Share	Master 50% Cost Share
Head of livestock = maximum number of single type, regardless of sex or age, at any one time during the last 12 months. *Applicant must meet at least one minimum program requirement at time of application. **This program is not available for individuals qualifying for the Beginning Farmer Option. Goats/Sheep can be combined to meet minimum head requirement. Hay Acreage = 100 acres in production; first cutting only				

Guidelines

Allowable purchase dates for Hay Equipment are from October 1, 2023 – April 1, 2024.

All items, regardless of backorder status, must be purchased (paid in full or financed) by the program reimbursement deadline. Backordered items may be ineligible for cost share if not delivered to the farm by the program deadline. *See p. 7 for more information regarding program requirements.*

Eligible Items

New Equipment Only

- ∅ *New items cannot be previously owned.*
- ∅ *Items purchased at an auction are considered used and are not eligible.*
- ∅ *Replacement parts are not eligible.*

1. Hay accumulator
2. Hay baler – round or square
3. Hay grapple
4. Hay mower (rotary cutter/pasture clippers are not eligible)
5. Hay mower caddy
6. Hay tedder
7. Hay rake
8. Mower-conditioner
9. Multi bale hay spear

Accessories are eligible for cost share if purchased along with equipment. *Additional parts are not eligible for cost share.*

Receipt Reminders

- **Receipts must be in the name of the applicant approved for cost share funding.**
- Receipts must also include:
 - Vendor name, address, phone number
 - Description of expense (make, model, serial #, if available)
 - Amount of purchase
 - Date of purchase
- **Quotes and purchase orders do not represent a purchase and are not considered receipts.**
 - Ask for a sales receipt if you are given a quote or purchase order.
 - It may take additional time for the sales representative to secure a sales receipt.
- **Proof of payment may be requested to verify purchase.**

Livestock Solutions

Minimum Requirements*	Certification Required to Apply	Beginning Farmer Option**	\$6,000 Maximum Reimbursement	
Cattle — 100 Head Goats/Sheep — 150 Head	BQA — Beef and Dairy	Not Available	Standard 35% Cost Share	Master 50% Cost Share
Head of livestock = maximum number of single type, regardless of sex or age, at any one time during the last 12 months. *Applicant must meet at least one minimum program requirement at time of application. **This program is not available for individuals qualifying for the Beginning Farmer Option. Goats/Sheep can be combined to meet minimum head requirement.				

Guidelines

Allowable purchase dates for Livestock Solutions are from October 1, 2023 - August 1, 2024.

All items, regardless of backorder status, must be purchased (paid in full or financed) by the program reimbursement deadline. Backordered items may be ineligible for cost share if not delivered to the farm by the program deadline. *See p. 7 for more information regarding program requirements.*

Eligible Items

New Only — Items 1 - 10

∅ *New items cannot be previously owned.*

∅ *Items purchased at an auction are considered used and are not eligible.*

∅ *Replacement parts are not eligible.*

1. Bunker/silage pit or pad — must have concrete floor
2. Commodity shed — new structures and additions to existing structures used for storage of bulk raw commodities; see p. 37 for minimum specifications and examples.
3. Feed bin — minimum 9 tons with optional auger and concrete pad
4. Feed lot scraper — skid steer/tractor mounted pusher blade/rubber attachment for cleaning heavy use feeding area
5. Manure spreader — minimum capacity 140 bushels; *not eligible — litter spreader*
6. Mobile working system — must be a mobile self-contained trailer unit; must include head gate, alley, and crowding/holding area
7. Self-unloading feed wagon — single or dual compartment “v” floor wagon with a vertical discharge auger
8. Multiple animal scale — load bars/platform, indicator, and optional concrete pad; *not eligible - single animal scale*
9. Silage bagger — machinery used for the bagging or debagging of silage
10. Unloading forage feeder wagon — silage/haylage wagon with a chain floor or pusher blade and side discharge

New or Used — Items 11 - 14

11. Bale processor/windrow bale feeder
12. Hay wrapper — machinery used for the wrapping of hay for use as haylage
13. Mixer wagon or grinder/mixer — equipment directly used to mix and/or grind hay, grain, and other supplements for feed
14. No-till pasture drill — minimum 10 ft. working width

Used equipment must meet all of the following criteria:

- ✓ **Less than 10 years old** - *check serial # and previous purchase documentation*
- ✓ Excellent working condition
- ✓ Minimal rust
- ✓ Reasonable market price

Tennessee Department of Agriculture may verify used equipment prior to payment.

Commodity Shed Examples

Minimum Specifications

1. No more than three EXTERIOR walls; *not eligible - completely enclosed buildings*
2. Structure must have at least four reinforced INTERIOR walls, 4 ft. minimum height
3. Minimum 14 ft. concrete apron
4. Two or more bays
5. Concrete floor
6. Minimum 960 sq. ft.
7. Minimum height requirements:
 - Monoslope roof - 18 ft. front
 - Gable roof - 16 ft.

Minimum Size 960 sq. ft. TOP VIEW

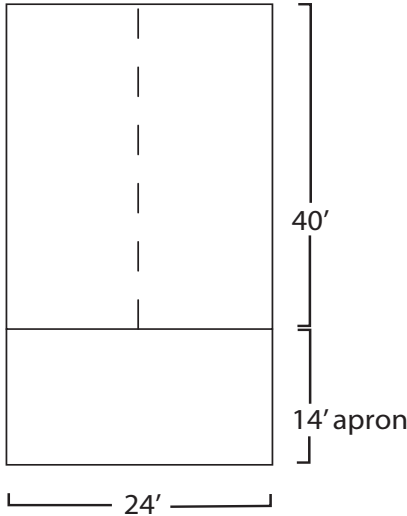

length (40 ft.) x width (24 ft.) = 960 sq. ft.

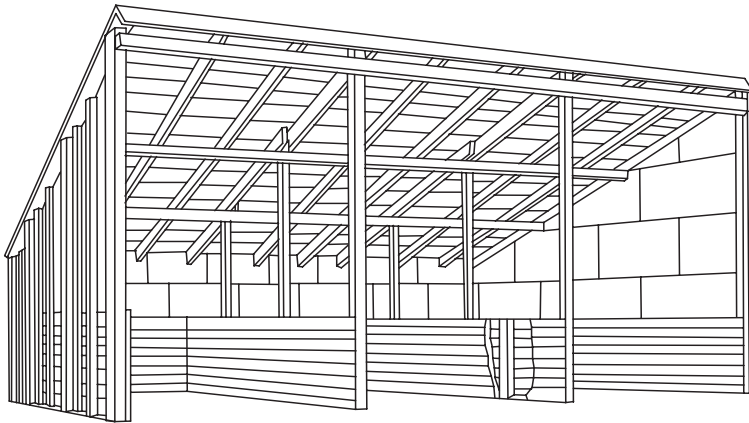

Monoslope Roof

SIDE VIEW

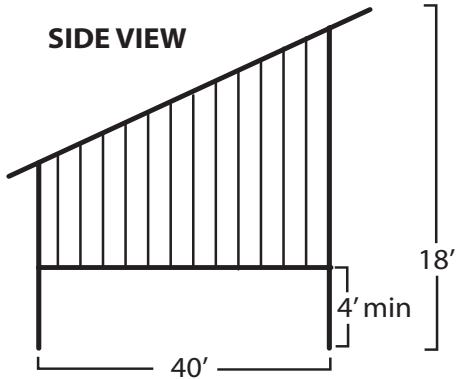

FRONT VIEW

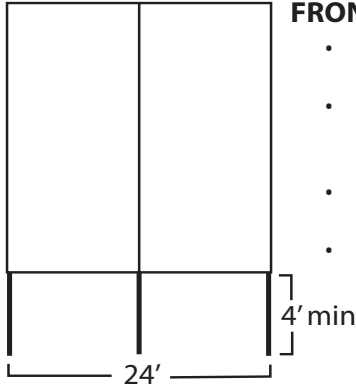

- Front - must be completely open
- Monoslope roof with reinforced walls, poured concrete or boards/planks
- Minimum of two bays
- INTERIOR walls must be a minimum of 4 ft. high

Gable Roof

SIDE VIEW

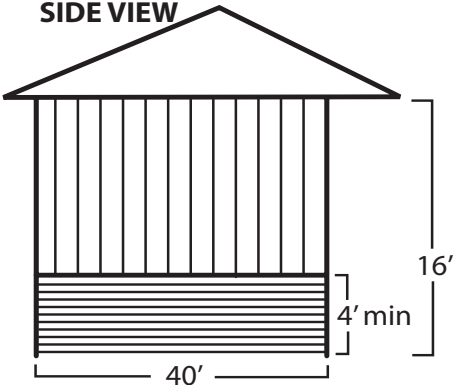

FRONT VIEW

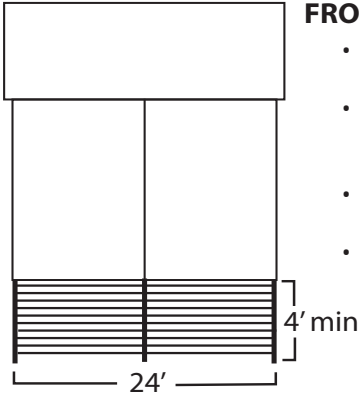

- Front - must be completely open
- Gable roof with reinforced walls, poured concrete or boards/planks
- Minimum of two bays
- INTERIOR walls must be a minimum of 4 ft. high

Poultry Grower

Minimum Requirements*	Certification Required to Apply	Beginning Farmer Option**	\$6,000 Maximum Reimbursement	
Broilers – 75,000/yr Non-Broilers – 10,000/yr	Not Applicable	Not Available	Standard 35% Cost Share	Master 50% Cost Share
*Applicant must be a commercial poultry producer meeting at least one of the minimum program requirements (broilers/non-broilers) at time of application.				
**This program is not available for individuals qualifying for the Beginning Farmer Option.				

Guidelines

Allowable purchase dates for Poultry Grower are from October 1, 2023 – August 1, 2024.

All items, regardless of backorder status, must be purchased (paid in full or financed) by the program reimbursement deadline. Backordered items may be ineligible for cost share if not delivered to the farm by the program deadline. *See p. 7 for more information regarding program requirements.*

Eligible Items

New or Used Equipment - Item 1

1. Propane Tank – above ground and for poultry use only; must be purchased and installed by a Tennessee licensed dealer and be ASME certified (American Society of Mechanical Engineers); 1,000-gallon minimum capacity (small capacity tanks of 500 gallons may be purchased to reach the minimum capacity); concrete pad or footers; contracted labor to install; *not eligible – electrical service*

New Equipment Only - Items 2 – 22

∅ *New items cannot be previously owned.*

∅ *Items purchased at an auction are considered used and are not eligible.*

∅ *Replacement parts are not eligible.*

2. Generator — for poultry use only, must be stationary, fixed mounted; minimum of 20 KW per house; concrete pad foundation; includes materials to connect and wire the generator; contract labor to install; *not eligible – portable/PTO generators*
3. Feed bin with optional auger and concrete foundation pad — for on farm storage of poultry feed only; must meet housing and feeding system specifications; contract labor to install; *not eligible – replacement parts*
4. Litter management equipment — must be designated by the manufacturer for poultry house use; equipment includes conveyors/elevators, pull-type spreaders (min. 140-bushel capacity), and poultry specific mounted implements used to windrow, de-cake (house cleaners), till, pulverize, level, and/or scrape walls for optimal litter management; *not eligible – self-propelled equipment, front end loaders, bucket attachments*
5. Overhead trolley system — aid in the removal of mortalities and transport supplies; manual or automated complete system; contract labor to install; *not eligible – electrical service*
6. Feed bin scales — automated feed bin scales and electronics; contract labor to install and interface; *not eligible – electrical service*
7. Poultry scales — automated poultry scales with hanging platform; contract labor to install and interface; *not eligible – electrical service*
8. Environmental pads — reinforced concrete pads for the front/receiving end of the poultry house to allow for better cleaning and disinfection before and after receiving poultry; recommended dimensions: 20' wide x 24' deep (front to back) x 6" thick; reinforced concrete, sloped away from the building; contract labor to install

Eligible Items

9. Poultry house cleaning equipment — must be designated for poultry house use for cleaning, washing down, and disinfecting the interior of the poultry house; minimum 540 RPM PTO driven sprayer and/or blower rigs; sprayer tank size must be a minimum 200 gallon and PTO driven; blower must be hydraulic or PTO driven; spray attachment optional
10. LED lights and dimmer controllers — must be purchased through a poultry supply company and specified for agricultural use; must have a 5-year warranty; includes LED light fixtures that contain fixed LEDs within the apparatus or built into the fixture as one unit; includes automated dimmer to accommodate higher efficiency LED lighting; contract labor to install and interface dimmer controller only; *not eligible - residential grade LED lights, electrical service, wiring, conduit, keyless fixtures*
11. Ventilation fans — must be designated for poultry house ventilation use and must be fixed mounted; tunnel fans, stir fans, minimal vent fans, controllers; contract labor to install; *not eligible - belts, blades, fan cones, shrouds, diffuser guards, mounting hardware*
12. Ventilation doors — side vents, attic vents, tunnel doors, and inlets; contract labor to install; *not eligible - louvers, shutters, mounting hardware*
13. Motors — to be used for the following: poultry house fans, ventilation systems, automated feeding systems and/or automated sidewall systems; *not eligible - pulleys, belts, bearing assemblies, labor to install, mounting hardware*
14. Feed-line gear boxes — for use with automated feeding systems; contract labor to install
15. End doors — must be designated for poultry house use; roll-up or bi-fold end door (crank or mechanical) for exterior of poultry house; contract labor to install; *not eligible - sliding doors, custom doors, handmade doors*
16. Curtains — must be designated by the manufacturer for poultry house use; sidewall drop curtains, inside divider curtains; *not eligible - labor to install*
17. Cool cell watering & ventilation systems — must be designated by the manufacturer for poultry house ventilation use; cool cell pads, cool cell pumps, sprinkler drops/spinners, controllers, pressure regulators, medicator pumps, injectors, and flush breather units specific for poultry house ventilation systems only; contract labor to install; *not eligible - nipples, water/plumbing lines, fixtures, mounting hardware*
18. Slats for hen houses — must be purchased through a poultry supply company and meet housing system specifications; preassembled plastic slats and pre-cut wooden slats, sticks and structural rail support systems; *not eligible - hardware, individual boards or lumber that is not purchased through a poultry supply store or itemized for wooden poultry slats*
19. Nesting pads for hen houses — must be designated by the manufacturer for poultry house use
20. Egg conveyor belts — conveyor belts; *not eligible - egg packers, tables, repairs*
21. Brooders and heaters — must be designated by the manufacturer for poultry house use; full section only; *not eligible - repairs, parts, labor*
22. Knee braces — must be made of metal and designated by the manufacturer for poultry house use; contract labor to install; *not eligible - repairs, parts, lags/bolts*

Swine Producer

Minimum Requirements*	Certification Required to Apply	Beginning Farmer Option**	\$6,000 Maximum Reimbursement	
Swine — 1,000 Head	PQA Plus — Swine	Not Available	Standard 35% Cost Share	Master 50% Cost Share
Head of livestock = maximum number of single type, regardless of sex or age, at any one time during the last 12 months. *Applicant must be a commercial swine producer meeting the minimum program requirement at time of application. **This program is not available for individuals qualifying for the Beginning Farmer Option.				

Guidelines

Allowable purchase dates for Swine Producer are from October 1, 2023 – August 1, 2024.

All items, regardless of backorder status, must be purchased (paid in full or financed) by the program reimbursement deadline. Backordered items may be ineligible for cost share if not delivered to the farm by the program deadline. *See p. 7 for more information regarding program requirements.*

Eligible Items

New or Used Equipment — Item 1

- Propane tank — above ground and for swine use only; must be purchased and installed by a Tennessee licensed dealer and be ASME certified (American Society of Mechanical Engineers); 1,000-gallon minimum capacity (small capacity tanks of 500 gallons may be purchased to reach the minimum capacity); concrete pad or footers; contracted labor to install; *not eligible – electrical service*

New Equipment Only — Items 2 - 14

∅ *New items cannot be previously owned.*

∅ *Items purchased at an auction are considered used and are not eligible.*

∅ *Replacement parts are not eligible.*

- Curtain — must be designated by the manufacturer for swine barn use; *not eligible – labor to install*
- Farrowing crate — commercially manufactured from swine supply company
- Farrowing crate flooring — commercially manufactured from swine supply company
- Generator — for swine production use only; must be stationary, fixed mounted; minimum of 20 KW per barn; concrete pad foundation; includes materials to connect and wire the generator; contract labor to install; *not eligible – portable/PTO generators*
- Heater — for use in gestation and nursery areas; contract labor to install; *not eligible – electrical service*
- Feed bin with optional auger and concrete foundation pad — for on farm storage of swine feed only; contract labor to install; *not eligible – replacement parts*
- Feed bin scale — automated feed bin scales and electronics; contract labor to install and interface; *not eligible – electrical service*
- Manure/lagoon agitator — for use in manure tanks and lagoon
- Manure/lagoon pump — for use in manure tanks and lagoons
- Manure spreader/injector — for liquid waste
- Nursery pen — commercially manufactured from swine supply company
- Ventilation fan — designed for swine barn ventilation use; must be fixed mounted; contract labor to install; *not eligible – belts, blades, fan cones, shrouds, diffuser guards, mounting hardware*
- Ventilation door — vents, tunnel doors, and inlets; contract labor to install; *not eligible – louvers, shutters, mounting hardware*

Quick Reference Guide

TAEP Application A Quick Reference Guide

Program	Livestock & Acreage Minimum Requirements Head of livestock refers to maximum number of single type, regardless of sex or age, at one time during the last 12 months. Goats/Sheep can be combined to meet minimum requirement. Hay acreage = acres in production; first cutting only. Row Crop acreage = acres in production of corn, cotton, soybeans, and/or wheat only.					
	Cattle <i>Beef/Dairy</i>	Goats/Sheep <i>Meat/Dairy</i>	Hay	Swine <i>Commercial</i>	Poultry <i>Commercial</i>	Row Crop <i>Corn, Cotton, Soybeans, Wheat</i>
Livestock Equipment	30 Head	50 Head				
Genetics						
Working Structures & Fence-line Systems						
Dairy Solutions						
Herd Health						
Hay Equipment	100 Head	150 Head	100 Acres			
Livestock Solutions	100 Head	150 Head				
Swine Producer				1,000 Head		
Poultry Grower					10,000/yr. – Nonbroilers 75,000/yr. – Broilers	
Row Crop Solutions						100 Acres

TAEP Application A - Beginning Farmer Option

Program	Cattle <i>Beef/Dairy</i>	Goats/Sheep <i>Meat/Dairy</i>	Row Crop <i>Corn, Cotton, Soybeans, Wheat</i>
Genetics	5-29 Head	10-49 Head	
Livestock Equipment			
Row Crop Solutions			25-99 Acres in production

See pp. 10 & 11 for Beginning Farmer Option requirements.

How To Apply

Frequently Asked Questions

Am I eligible to apply for TAEP?

Review TAEP's eligibility requirements on p. 6 to determine if you meet basic requirements.

How to determine if I qualify for a program?

- Review program descriptions and livestock/acreage minimum requirements to determine the programs for which you qualify. Verification of minimum requirements may be requested prior to approval.
 - Head of livestock refers to the maximum number of single type, regardless of sex or age, at any one time during the last 12 months.
 - Goats/Sheep can be combined to meet minimum head requirement.
 - Poultry growers must be commercial growers to qualify.
 - Swine producers must be commercial growers to qualify.

Do I need any certifications or permits to apply?

- Cattle producers are required to have a current BQA at time of application.
- Dairy producers must be permitted by TDA to be eligible as a dairy at time of application.
- Swine producers must be Pork Quality Assurance (PQA) Plus certified at time of application.

How to Apply?

- Applications must be submitted during the application period (October 1-7, 2023).
- Applications may be submitted by mail, online, or hand delivery only.

What are the advantages to applying online?

- Ensures all sections of the application are completed.
- Verifies application was received by sending a confirmation email.
- Efficient. Eliminates a trip to the post office to mail.

Who can apply online?

- New applicants.
- Returning applicants.

Do I need a TAEP Producer Number (TPN) to apply online?

- No, it is not necessary to have a TPN to apply online.
- New applicants will not have a TPN.
- Returning applicants can apply without listing their TPN.

Do I need a TAEP Account to apply online?

- No, a TAEP Account is not required to apply online.
- New applicants will not have a TPN and will not be able to create an account within the TAEP Account Portal.
- ***The TAEP Account Portal is separate from the online application. The application link does not exist within the TAEP Account Portal.***

What do I need to apply online?

- Access to the internet – applicant must have a functional internet connection to submit an online application.
- Electronic device – computers, laptops, and tablets are preferred over smartphones.
- Valid email address – applicant must be able to send and receive emails.

Where do I go to apply online?

- Visit www.tn.gov/taep during the application period (October 1-7, 2023).
- Click on the red "APPLY NOW – TAEP Application A" button.

How do I know my online application was submitted?

- Applicant will receive an email from taep.online@tn.gov confirming application was submitted. The confirmation email will indicate program selected.
- Check spam/junk folder if confirmation email is not received within 15 minutes of submitting application.
- Applicant is encouraged to keep a copy of email confirmation as proof of applying.

Can I change my program request after applying?

- Applicant will not be allowed to change cost share program after the application period ends (October 7, 2023).
- Review application accuracy prior to submitting. Always double check your program request and minimum requirements.

Proof of Applying

It is recommended to secure proof of applying for TAEP cost share funding. Forms of proof include:

- Paper application – copy of application and tracking receipt showing application was mailed during the application period (October 1-7, 2023).
- Online application – copy of application confirmation email from taep.online@tn.gov.

Paper Application

Paper applications must be mailed to TDA.

TAEP 2023 - A
P.O. Box 40627
Nashville, TN 37204

Paper applications must have a postmark ranging from October 1-7, 2023.

- Applications are not accepted by email, fax, or text.
- Hand delivery between October 1 – 7, 2023 during normal business hours. Contact TAEP office prior to hand delivery in 2023.

Tip: Applicants are encouraged to keep a copy of their application materials and mail the original using a traceable method of delivery. For example, USPS Certified Mail with Return Receipt method will provide the sender with evidence of delivery (to whom the mail was delivered and date of delivery). It is not necessary to overnight, UPS, or FedEx application.

Online Application

Applicants may apply electrically via a live link at www.tn.gov/taep during the application period (October 1-7, 2023) by clicking on the red **“APPLY NOW – TAEP Application A”** button. The online application allows for both new and returning applicants to apply. Applying online ensures all sections of the application are complete and verifies the application was received by sending a confirmation email to the applicant. Applicant must have a valid email address to apply online.

Instructions for Application A

Review program descriptions and requirements to determine which programs you are eligible for and if any program specific certifications/permits are required to apply. Complete all sections of the application.

1. APPLICANT INFORMATION

- Name – enter your full legal name and indicate your title and any suffix you may have
Tip: Applicant name must match name on educational certifications and permits.
- Social Security Number — list only the last four digits of your social security number; additional taxpayer information will be collected at time of reimbursement; participants will receive Form 1099-G for payments over \$600
- Mailing Address — enter the address where you receive your mail; TAEP documentation will be sent to this address
- Farm County — enter the county where your TAEP project will be located
- Home Address — enter the address where you live; the home address may be the same as your mailing address; P.O. Boxes are not accepted as a home address
- Home Phone & Cell Phone — enter available contact numbers
- Email — enter current email address (optional)

2. FARMING HISTORY

List the year you started farming your operation. *Example - 2005*

3. TAEP PRODUCER NUMBER (TPN)

The TAEP Producer Number (TPN) is a unique number used to identify each applicant. The TPN is exclusive to an individual and cannot be transferred. If you have applied for TAEP within the past three years, your TPN will be mailed to you in September. Please include your TPN on the application form and any other TAEP correspondence. **New applicants will not have a TPN until their first application is processed.**

4. APPLICATION CERTIFICATIONS/PERMITS

Applicant Certifications/Permits — BQA and PQA certifications must be current at the time of application and completed by the applicant. No substitutions allowed. Dairy producers must be permitted by TDA at time of application to be eligible as a dairy. *Master certifications are submitted at time of reimbursement.*

5. LIVESTOCK AND ACREAGE INFORMATION

Livestock/Acreage – each program has a minimum number of livestock/acreage requirements. **The applicant must meet at least one of the minimum requirements for the program applied for.** Verification of minimum requirements may be requested prior approval. *Reduced minimum requirements available for applicants who qualify for Beginning Farmer Option. See pp. 10-11.*

- Head of Livestock = maximum number of single type, regardless of sex or age, at any one time during the last 12 months
- Hay Acreage = acres of hay in production; first cutting only
- Row Crop Acreage = acres in row crop production of corn, cotton, soybeans, and/or wheat only

6. COST SHARE REQUEST

Cost Share Request — **Check only one (1) program.** Checking multiple boxes will void your cost share request. You will not be able to change your cost share request after October 7, 2023.

7. BEGINNING FARMER OPTION

Indicate if you qualify for the TAEP Beginning Farmer Option. See pp. 10-11 to determine eligibility.

8. APPLICANT AGREEMENT

Applicant Agreement — this section features several important bullet points regarding program participation and compliance. **Read each line of text.** Print your name and date. Sign your name.



2023 TAEP Cost Share - Application A

Official Use Only

Important! This form will be scanned. Please complete in CAPITAL LETTERS using a black or dark blue ink pen. Do not use a felt tip pen, pencil, or marker. Leave boxes blank to indicate spaces. Please do not write outside the boxes.

1. APPLICANT INFORMATION

Last Name: [Grid]

First Name: [Grid]

Middle Name: [Grid]

Title: MR MRS MS MISS Suffix: JR SR II III IV

Social Security Number - Last four digits only: X X X - X X - [Grid]

This is for identification purposes ONLY. Applicant will provide taxpayer information at time of reimbursement.

Mailing Address: [Grid]

City: [Grid]

State: [Grid] Zip: [Grid] Farm County: [Grid]

Home Address: [Grid]

City: [Grid]

State: [Grid] Zip: [Grid]

Home Phone: [Grid] - [Grid] - [Grid] Cell Phone: [Grid] - [Grid] - [Grid]

Email: [Grid]

2. FARMING HISTORY: List the year you started farming your operation: [Grid]

Farm Operation Participation - only one person from your farming operation may apply for Application A.

3. TAEP PRODUCER NUMBER (TPN): [Grid] New TAEP applicants will not have a TPN until applications are processed.

4. APPLICANT CERTIFICATION/PERMITS: Certifications/permits must be current (not expired) and in the applicant's name. No substitutions allowed. Master certifications are submitted at time of reimbursement.

Beef Quality Assurance BQA# - Required for cattle: [Grid]

BQA# - Expiration Date: [Grid] / [Grid] / [Grid]

TDA Dairy Permit#: T [Grid] - [Grid]

5. LIVESTOCK AND ACREAGE INFORMATION

- Head of livestock = maximum of single type, regardless of sex or age, at any one time during the last 12 months
- Hay acreage = acres of hay in production; first cutting only
- Row crop acreage = acres in row crop production of corn, cotton, soybeans, and/or wheat

Check Type

List # of Head/Production Areas

<input type="checkbox"/> Cattle	<input type="text"/>	<input type="text"/>	<input type="text"/>	<input type="text"/>	<input type="text"/>	<input type="text"/>	<input type="text"/>	<input type="text"/>	<input type="text"/>	<input type="text"/>	<input type="text"/>	<input type="text"/>	<input type="text"/>	<input type="text"/>	<input type="text"/>	<input type="text"/>	<input type="text"/>	<input type="text"/>	<input type="text"/>	<input type="text"/>
<input type="checkbox"/> Goats/Sheep	<input type="text"/>	<input type="text"/>	<input type="text"/>	<input type="text"/>	<input type="text"/>	<input type="text"/>	<input type="text"/>	<input type="text"/>	<input type="text"/>	<input type="text"/>	<input type="text"/>	<input type="text"/>	<input type="text"/>	<input type="text"/>	<input type="text"/>	<input type="text"/>	<input type="text"/>	<input type="text"/>	<input type="text"/>	<input type="text"/>
<input type="checkbox"/> Swine	<input type="text"/>	<input type="text"/>	<input type="text"/>	<input type="text"/>	<input type="text"/>	<input type="text"/>	<input type="text"/>	<input type="text"/>	<input type="text"/>	<input type="text"/>	<input type="text"/>	<input type="text"/>	<input type="text"/>	<input type="text"/>	<input type="text"/>	<input type="text"/>	<input type="text"/>	<input type="text"/>	<input type="text"/>	<input type="text"/>
<input type="checkbox"/> Row Crop	<input type="text"/>	<input type="text"/>	<input type="text"/>	<input type="text"/>	<input type="text"/>	<input type="text"/>	<input type="text"/>	<input type="text"/>	<input type="text"/>	<input type="text"/>	<input type="text"/>	<input type="text"/>	<input type="text"/>	<input type="text"/>	<input type="text"/>	<input type="text"/>	<input type="text"/>	<input type="text"/>	<input type="text"/>	<input type="text"/>
<input type="checkbox"/> Hay	<input type="text"/>	<input type="text"/>	<input type="text"/>	<input type="text"/>	<input type="text"/>	<input type="text"/>	<input type="text"/>	<input type="text"/>	<input type="text"/>	<input type="text"/>	<input type="text"/>	<input type="text"/>	<input type="text"/>	<input type="text"/>	<input type="text"/>	<input type="text"/>	<input type="text"/>	<input type="text"/>	<input type="text"/>	<input type="text"/>
<input type="checkbox"/> Poultry - Broilers	<input type="text"/>	<input type="text"/>	<input type="text"/>	<input type="text"/>	<input type="text"/>	<input type="text"/>	<input type="text"/>	<input type="text"/>	<input type="text"/>	<input type="text"/>	<input type="text"/>	<input type="text"/>	<input type="text"/>	<input type="text"/>	<input type="text"/>	<input type="text"/>	<input type="text"/>	<input type="text"/>	<input type="text"/>	<input type="text"/>
<input type="checkbox"/> Poultry - Non-broilers	<input type="text"/>	<input type="text"/>	<input type="text"/>	<input type="text"/>	<input type="text"/>	<input type="text"/>	<input type="text"/>	<input type="text"/>	<input type="text"/>	<input type="text"/>	<input type="text"/>	<input type="text"/>	<input type="text"/>	<input type="text"/>	<input type="text"/>	<input type="text"/>	<input type="text"/>	<input type="text"/>	<input type="text"/>	<input type="text"/>

6. COST SHARE REQUEST

Check only one (1) program. Checking multiple boxes will void your cost share request.

- | | |
|--|---|
| <input type="checkbox"/> Dairy Solutions | <input type="checkbox"/> Livestock Solutions |
| <input type="checkbox"/> Genetics | <input type="checkbox"/> Working Structures (Cover or Pen) & Fence-line Systems |
| <input type="checkbox"/> Hay Equipment | <input type="checkbox"/> Poultry Grower |
| <input type="checkbox"/> Herd Health | <input type="checkbox"/> Row Crop Solutions |
| <input type="checkbox"/> Livestock Equipment | <input type="checkbox"/> Swine Producer |

7. BEGINNING FARMER OPTION

Do you qualify for the TAEP Beginning Farmer Option? Yes No

See pp. 10-11 for information about qualifying for the Beginning Farmer Option.

8. APPLICANT AGREEMENT

- I warrant that I have carefully read and understand this application booklet and all requirements, guidelines, and criteria contained therein.
- I understand that it is solely my responsibility to ensure my project is eligible for TAEP funding and that failure to comply with all TAEP requirements, guidelines, and criteria may result in denial of my application, denial of any or all reimbursement payments, repayment of cost share funds, and/or suspension from TAEP.
- I certify that all information provided by me is complete, true, and accurate to the best of my knowledge and belief.
- I understand that providing any false, fraudulent, or misleading information to the Tennessee Department of Agriculture may result in suspension of my operation from TAEP, civil litigation, and/or criminal prosecution.

Print Name:

Date: / / Signature:

9. HOW TO SUBMIT

- Applicant will be notified in writing of approval or denial of application by mid-December
- It is recommended to make a copy and mail the original using a traceable method of delivery
- Paper applications must have a postmark date ranging from October 1 - 7, 2023
- Mail to: **TDA, TAEP 2023 - App A, P.O. Box 40627, Nashville, TN 37204**

Additional Information

Taxable Income

Funds received as a result of TAEP reimbursement are taxable. Participants will receive Form 1099-G for reimbursement payments over \$600.00.

Nondiscrimination

The Tennessee Department of Agriculture prohibits discrimination against persons based on their race, color, national origin, sex, age or disability. Any person alleging discrimination based on a prohibited basis has a right to file a complaint within 180 days of the alleged discrimination with the Tennessee Department of Agriculture and/or the Tennessee Human Rights Commission. For more information contact TDA's Human Resources office at 615-837-5116.

Public Disclosure

Under Tennessee's Public Records law, information provided to the state becomes public record and is open to public inspection unless otherwise protected by state or federal law.

A public record is defined as all documents or materials, regardless of physical form or characteristics made or received in connection with the transaction of official business by any governmental agency. Please be aware that information collected by the Tennessee Department of Agriculture could be made available to the public upon request by any citizen of the state. Requests for public records will be examined for compliance with public record laws.

TAEP Contact Information

dairy.solutions@tn.gov
hay.equipment@tn.gov
herd.health@tn.gov
livestock.equipment@tn.gov
livestock.genetics@tn.gov
livestock.solutions@tn.gov
poultry.grower@tn.gov
producer.diversification@tn.gov
rowcrop.solutions@tn.gov
swine.producer@tn.gov
working.structures@tn.gov
taep.online@tn.gov

Tennessee Agricultural Enhancement Program

Tennessee Department of Agriculture • Ellington Agricultural Center
P.O. Box 40627 • Nashville, TN 37204

Information Line

1.800.342.8206



Physical Address:

Ellington Agricultural Center • Holeman Building • 424 Hogan Road • Nashville, TN 37220



Tennessee Department of Agriculture. Authorization No. 325372,
25,000 copies, July 2023. This public document was promulgated at
a cost of \$0.65 per copy.