



**TDOT**

Department of  
Transportation

# CNX091 Hardin Co. SR-128 over Pickwick Dam

*PIN 123145.00*

*State Project Number: 36010-0227-94*

*Federal Project Number: BH-STP/HIP-128(29)*

# Project Overview

- Letting Date: March 31, 2023
- The rehabilitation of the bridge on SR 128 over the Pickwick Dam (LM 0.84)
- Scope of Work- detailed in design portion
- Completion Date: On or before 5/31/2026
- ADT: 7500
- Designer: HDR

# Project Commitments

- An asbestos containing material survey was conducted. No ACM was detected. No special accommodations for demolition and waste disposal are anticipated for this structure and the material can be disposed of in a C&D landfill.
- Prior to the demolition or rehabilitation of any structure (bridge or building), the contractor is required to submit the National Emission Standards for Hazardous Air Pollutants standard 10-day notice of demolition to the TDEC Division of air pollution control (Standard Specifications for Road and Bridge Construction (January 1, 2021) Sections 107.08D and 202.03).
- Due to the presence of state and federally listed species, no in-stream work may occur in the Tennessee River, additionally, no sediment or construction material should be allowed to enter the Tennessee River.
- Cliff Swallow and Barn Swallow nests, eggs, or birds (young and adults) will not be disturbed between April 15 and July 31. From August 1 to April 14, nests can be removed or destroyed, and measures implemented to prevent future nest building at the site. (E.G. closing off area using netting)

# SP108B

- All bridge closures must be approved in advance by the Engineer. A minimum of seven days' notice must be provided in advance of any closure. Weekend bridge closures shall be allowed from 6:00 P.M. Friday until 6:00 A.M. the following Monday. For each hour, or portion thereof, in which a lane is closed to traffic outside of these restrictions, the contractor will be charged \$2,000 per hour per lane, not as penalty, but as liquidated damage. **A maximum of twenty-four (24) weekend closures** shall be permitted. No lane closures will be allowed during Special Events, Holidays or Holiday weekends in accordance with the plans and specifications, or as directed by the Engineer.
- Temporary traffic signals are to be used during construction while the bridge is open to traffic. The maximum wait time for traffic at the temporary signals shall be no more than **three (3) minutes**.

# Items of Interest

- **712-02.47 Bridge Mounted Interconnected Barrier Rail 1257 LF**
- Cost shall include patching bolt holes in new deck.
- Cost of relocating the rail during traffic control phases to be included in the price for this item. (Note 18)
  
- **730-40 Traffic Signal System 1 LS**
- **712-02.60 Temp. Crash Cushion 2 EA**
- **712-06 Signs (Construction) 816 SF**
- **712-07.03 Temporary Barricades (Type III)**
- **712-04.01 Flexible Drums 17 EA**
- Cost of relocating during traffic control phases to be included in the price for this item.

# Design Contacts

- Joseph Bender, E.I. | TDOT Structures
  - [Joseph.Bender@tn.gov](mailto:Joseph.Bender@tn.gov)
- Sean Montgomery, E.I. | TDOT Structures
  - [Sean.Montgomery@tn.gov](mailto:Sean.Montgomery@tn.gov)
- Shawna Smith, P.E. | TDOT Construction
  - [Shawna.B.Smith@tn.gov](mailto:Shawna.B.Smith@tn.gov)
- Josh Harper | TVA
  - [Jwharper@tva.gov](mailto:Jwharper@tva.gov)
- Carter Bearden, P.E. | HDR
  - [Carter.Bearden@hdrinc.com](mailto:Carter.Bearden@hdrinc.com)
- Larry Miller, P.E. | HDR
  - [Larry.Miller@hdrinc.com](mailto:Larry.Miller@hdrinc.com)
- Evan Graves, P.E. | HDR
  - [Evan.Graves@hdrinc.com](mailto:Evan.Graves@hdrinc.com)

# Project Location

- Hardin County
- Repair of SR-128 Bridge over Pickwick Dam

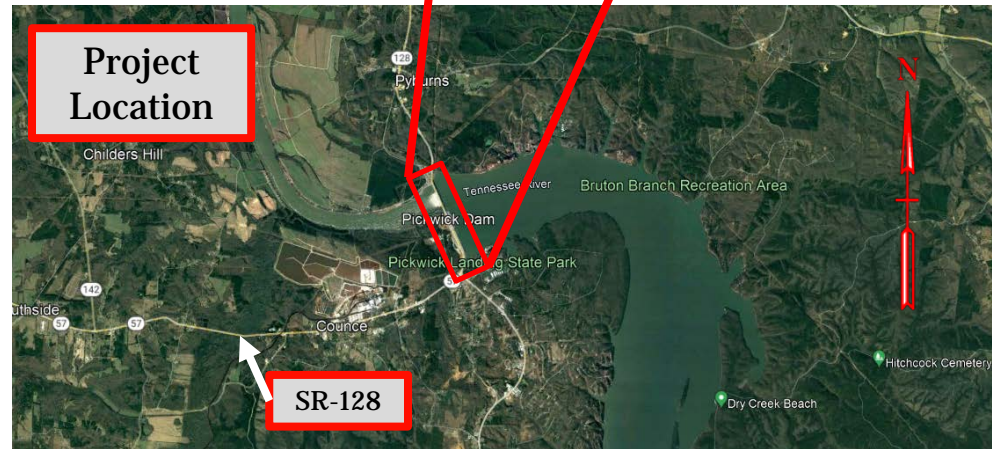

# Project Information

- Scope of Work
  - Replace Existing Deck with New Lightweight Concrete Deck
  - Install shear studs on existing beams & girders
  - Construct new single slope bridge rails with appropriate items for bridge lighting
  - Repair rocker bearings at bents D3, DT2S, DT4N, and L2
  - Replace cast iron drainage system
  - Replace existing strip seal joints at designated locations
  - Replace existing finger joints with modular joints
  - Remove all cantilever brackets
  - Provide temporary shoring for deck repairs
  - Repair deteriorated steel at designated locations
  - Spot paint on all new steel and at designated locations
  - Mount existing light poles to new bridge rail
  - Place new 5' fencing on top of new bridge rail
  - Remove and dispose of existing bridge netting after deck replacement
  - Install guardrail connections to bridge ends



# Sequence of Construction

- Install containment platform to prevent debris from falling to the ground below.
- Install traffic control utilizing temporary signals to close the Northbound lane
- Install temporary shoring for spans 17-41
- Sawcut the deck along the centerline of the center stringer
- Make transverse saw cuts as needed to remove portions of deck. NOTE: Contractor shall submit a demolition plan with calculations that ensures the existing girders will not be overstressed during removal operations. Deck removal can occur during weekend closures, as specified in Special Provision 108B.

# Sequence of Construction (cont.)

- Clean top flanges of structural steel members and apply prime coat. Install welded shear studs to beams, girders, and stringers.
- Install deck forms and place rebar for new deck for Pour Number 1 (positive moment regions), as specified in plans.
- Place lightweight concrete for Pour Number 1. This can be done through weekend closures as specified in Special Provision 108B.
- Install deck forms and place rebar for new deck for Pour Number 2 (negative moment regions), as specified in plans.

# Sequence of Construction (cont.)

- At locations of expansion joint replacement, remove the joint, modify structural steel as needed and install Phase 1 of the new joint.
- After Pour Number 1 has cured for minimum 72 hours, place lightweight concrete for Pour Number 2. This can be done through weekend closures as specified in Special Provision 108B.
- After Pour Number 2 has reached 3,000 psi strength, the new parapet may be placed.
- After the parapet has reached 3,000 psi, modify traffic control to open Northbound lane and close Southbound lane.

# Sequence of Construction (cont.)

- Repeat previous steps to complete demo and construction of Southbound lane.
- Contractor may submit an alternate construction sequence for the approval from TDOT and TVA.

# Traffic Control- Phase 1

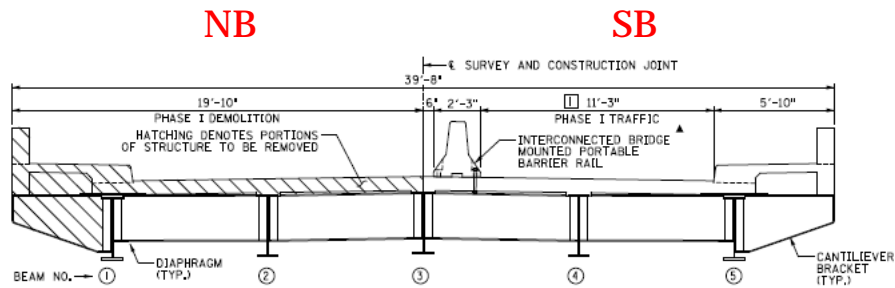

TYPICAL SECTION - SPANS 1-16

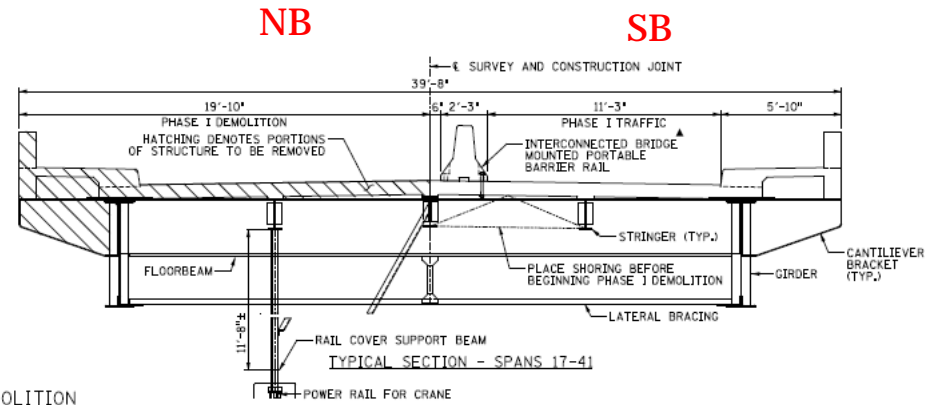

TYPICAL SECTION - SPANS 17-41

PHASE I DEMOLITION  
(LOOKING FORWARD ON SURVEY)

ALL FALSEWORK MUST BE ABOVE THE SUPPORT BEAM OF THE COVER OF THE CRANE POWER RAIL. RAIL EXTENDS FROM BENT D2 TO BENT D14.

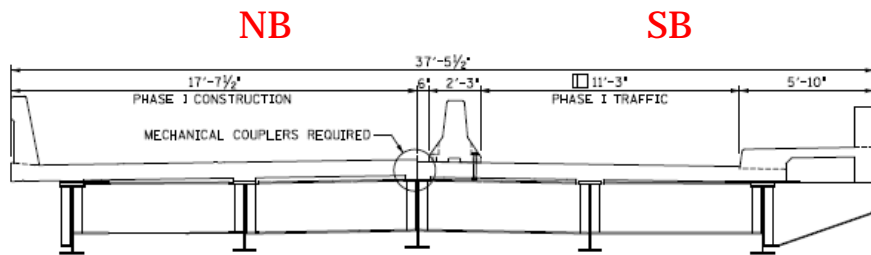

TYPICAL SECTION - SPANS 1-16

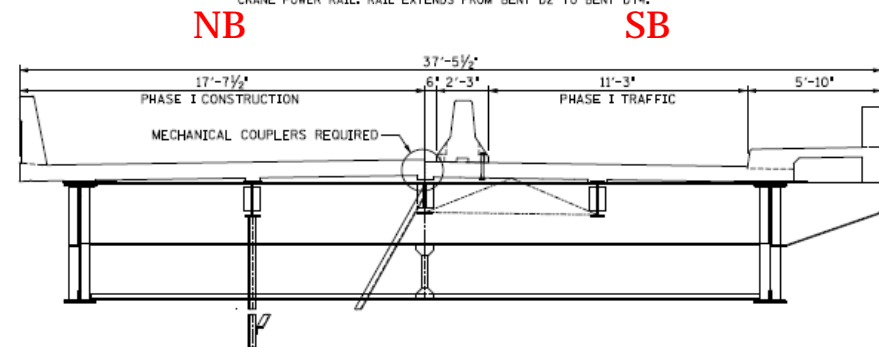

TYPICAL SECTION - SPANS 17-41

PHASE I CONSTRUCTION  
(LOOKING FORWARD ON SURVEY)

# Traffic Control- Phase 2

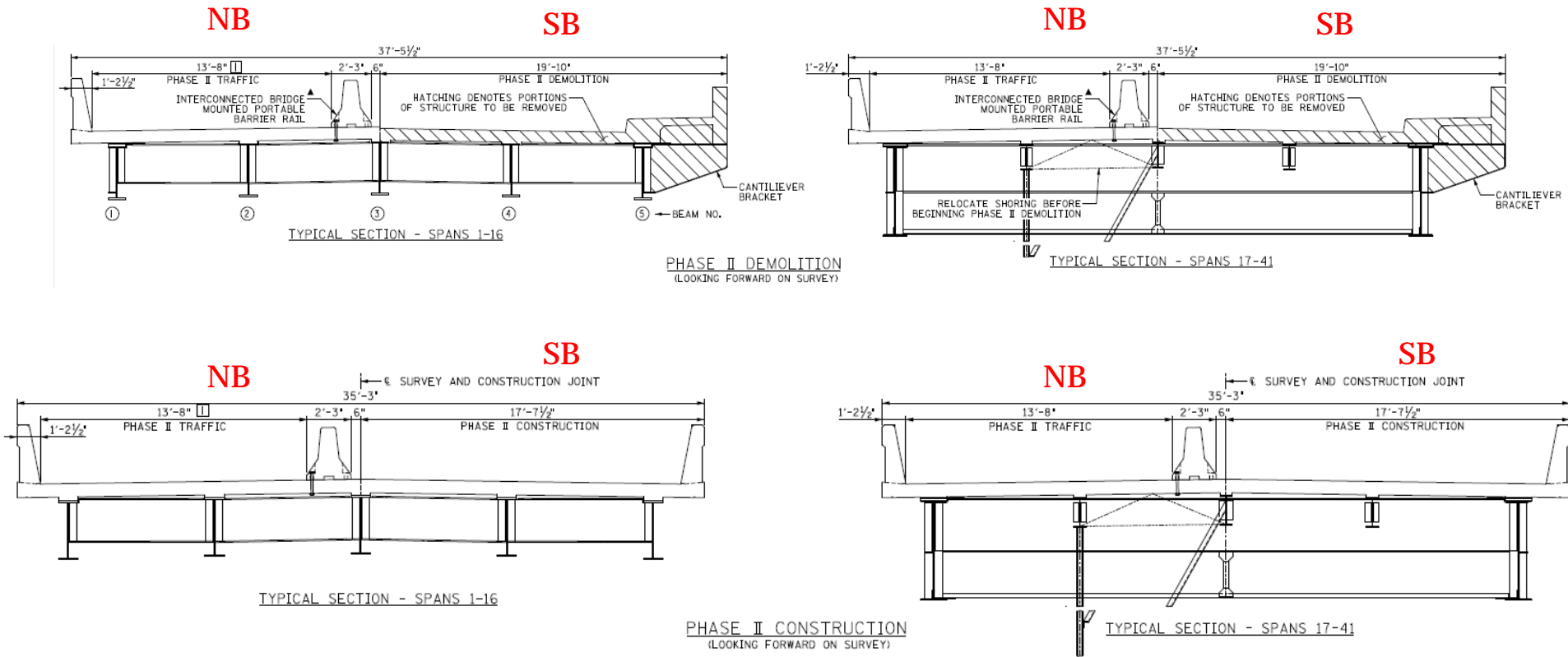

# Detour

- 35 Mile Detour
- Utilizes SR-22, SR-142, US-64
- 24 Total Weekend Detours

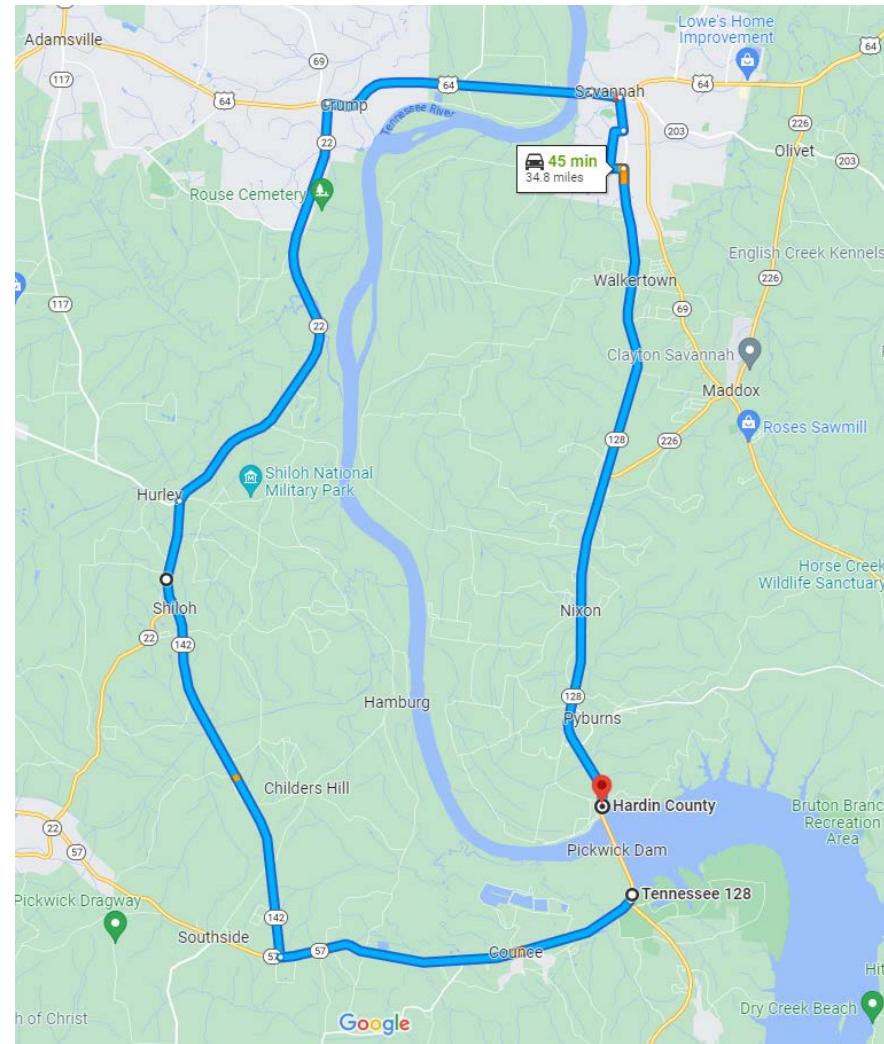

# Construction Constraints

- The deck of the dam or the lock area will not be used as a work area, for material staging, or for heavy equipment setup. These areas must remain operational at all times.
- The contractor will develop and submit for approval a plan to protect TVA and CORPS personnel and equipment from falling debris. This plan will remain in place for the duration of the project.
- Blasting, heavy impact hammers, or conventional wrecking ball methods cannot be used.
- All welding and cutting must not endanger any personnel or equipment of the dam.
- High hazard fall protection plans shall be submitted to TVA for review and approval before the contractor begins any work.



# Construction Constraints (cont.)

- Any activities that will disrupt navigation through the lock or any other activities of the dam shall be minimized and must be coordinated with TVA and CORPS.
- Removal of deck sections over the lock chamber have the following requirements:
  - Work over the lock chamber shall be no more than 24 hour increments. 24 hour outages cannot occur on consecutive days.
  - Initial schedule planning is to provide a minimum notification of 3 months prior to the anticipated closure dates.
  - Exact schedule to be developed and coordinated with CORPS with a minimum notification of 4 weeks.
  - All contractor equipment shall be capable of quick removal (4 hours) in the event of an emergency.

# Construction Constraints (cont.)

- Closures around the lock shall be minimized during peak season (June – September).
- Any needed lock closures are to be scheduled on Tuesday, Wednesdays, or Thursdays.
- No floating equipment will be used.
- TVA will identify the area for construction staging for contractor's use on the south side of the dam.
- ALL contractor employees working on the project will be subject to TVA security and badging requirements. Any contractor employee who requires access to secured areas will be required to be fingerprinted and have a background check. A site orientation will be conducted that covers plant requirements such as site specific training, lockout tagout procedures, etc. for employees requiring access into secured areas.

# Construction Constraints (cont.)

- Contractor is to submit a plan for disposal of all bridge deck and structural steel materials.
- Contractor to submit an Environmental Management Plan for any laydown areas and jobsite.
- Contractor to develop and submit to TDOT and TVA for review a “Fuel Handling and Fueling Procedure” which will be implemented on this project. Please see plans for additional details.

# Construction Constraints (cont.)

- All contractors bidding on the project shall provide a certificate of insurance evidencing that they carry the following types and amounts of insurance:
  - Workers compensation insurance- Statutory limits
  - Commercial General Liability Insurance- \$10 million per occurrence
  - Auto Liability Insurance- \$2 million per occurrence
  - See plans for additional requirements for insurance.
- Contractor shall provide at least 30 days written notice of cancellation, expirations without renewal, and terminations of insurance policies. Contractor shall carry above insurance throughout the contract and shall furnish certification upon request from TVA or TDOT.

# Construction Constraints (cont.)

- 24 total weekend closures
- 3 closures per phase per segment, 8 total phases (only 2 phases of traffic control)
- All locations of Pour Number 1 must be completed before all locations of Pour Number 2 can begin.
- All pour locations are specified in the plans, under the “SUPERSTRUCTURE REPAIR DETAILS” (sheets 21-27).

# TVA Special Provision Submittals Summary

- A detailed plan and schedule for the demolition of the bridge deck and superstructure
- A plan specifying the extent and methods to be used to protect TVA and CORPS equipment prior to the start of demolition operations
- Environmental Management Plan for laydown areas and jobsite
- Fuel Handling and Fueling Procedure
- Summary of required insurance coverage

# TVA – Josh Harper

- Protection plan for Hydro Plant/Lock personnel and assets
- Communication with Hydro Plant/Lock personnel
- Priority of Plant/Lock operations
- Badging/training requirements for access inside secured area

# TVA Dam Contacts

- **US Coast Guard, Eric Washburn 341-269-2500**
- **USACE Lock Master & Pickwick Dam Foreman, Josh Fisher 731-607-3030**
- **Dam Safety, Bernie Auld 615-804-7290**
- **USACE Pickwick Lock 731-925-2334**
- **TVA Pickwick Hydro Plant 731-926-4823**



# Questions

Please send all RFI's to [shawna.b.smith@tn.gov](mailto:shawna.b.smith@tn.gov) by March 24<sup>th</sup>.

Shawna Smith, Assistant Director Construction Region 4  
731-431-6430



**THANK YOU**