

Tennessee Agricultural Enhancement Program

A Cost Share Program for Tennessee Farmers

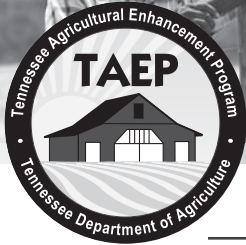

Strengthening Today's Farms for the Future of Tennessee!

TAEP is strengthening agriculture in Tennessee by providing cost share funds for long term investments in Tennessee's livestock and farming operations. TAEP is a direct result of the State of Tennessee's commitment to supporting its agricultural community.

Application Guide

Eligibility Requirements	2	Livestock Feed Storage	10
Application Rules	3	Grain Storage	12
Application A - Quick Reference Guide ..	4	Application A	15
Cattle Genetics	5	Producer Diversification	17
Livestock Equipment	6	Application B.....	21
Hay Storage	8	TAEP in Action.....	23

2011 Producer Cost Share Opportunities

Program	Eligible Industry	Cost Share Maximums		Application Period	Reimbursement Deadline
		35% Standard Producer	50% Master Producer		
Cattle Genetics	Cattle	\$1,200 Max	\$1,200 Max	June 1 - June 7, 2011	May 1, 2012
Livestock Equipment	Cattle, Goats/Sheep	\$3,500 Max	\$3,500 Max	June 1 - June 7, 2011	Dec 1, 2011
Hay Storage	Cattle Goats/Sheep, Hay	\$7,500 Max	\$7,500 Max	June 1 - June 7, 2011	May 1, 2012
Livestock Feed Storage	Cattle, Goats/Sheep, Poultry, Swine	\$10,000 Max	\$10,000 Max	June 1 - June 7, 2011	Dec. 1, 2011
Grain Storage	Corn, Soybeans, Wheat, Other	\$15,000 Max	Not Available	June 1 - June 7, 2011	May 1, 2012
Producer Diversification	Agritourism Fruits and Vegetables Honey Bees Organics	\$10,000 Max	\$15,000 Max	June 1 - June 7, 2011	May 1, 2012
	Aquaculture Horticulture Value-Added Products Viticulture	\$10,000 Max	Not Available	June 1 - June 7, 2011	May 1, 2012

Eligibility Requirements

1. Applicant must be an individual **Tennessee resident** operating a farm located in Tennessee.
2. Applicant must be at least 18 years old on application date.
3. Applicant must have the ability and financial capacity to complete the project.
4. Applicant must meet minimum livestock/acreage requirements for each program applied for, where applicable.
5. Applicant must own land where **permanent structures** will be built.

See Hay Storage, Livestock Feed Storage, Grain Storage, and Producer Diversification programs for more information. Livestock Equipment projects can be located on leased land.

6. **Premises registration** is required for applicants with livestock on their operations.

Premises registration forms and instructions are available from TDA at www.tennessee.gov/agriculture/regulatory/livestock.html or by calling 615-837-5120.

7. Beef and Dairy cattle producers must have current **TN Beef Quality Assurance Certification (BQA)** at date of application.

BQA is a two-hour educational course on cattle management and care sponsored by the Tennessee Cattlemen's Association (TCA). BQA numbers must be renewed every two years and **CURRENT** at time of application. Contact TCA for additional information on BQA classes at 615-896-2333, info@tncattle.org, www.tncattle.org or your local UT Extension office, www.utextension.utk.edu.

8. Swine producers must have current **Pork Quality Assurance Plus Certification (PQA)**.

PQA Plus is a two-hour educational course on swine management and care sponsored by the Tennessee Pork Producers Association (TPPA). PQA numbers must be renewed every three years and **CURRENT** at time of application. Contact TPPA for additional information on PQA Plus classes at 615-274-6533 or tnpork@tds.net.

9. Dairy producers (cattle, goats, and sheep) must be permitted by TDA to be eligible as a dairy.

Contact TDA Regulatory Services, Food and Dairy Division, at 615-837-5193, for permit information.

10. Certifications, permits and other priority requirements as specified by program must be **completed by the applicant**. No substitutions allowed. This applies to BQA, PQA, dairy permit, premises registration, and master producer certifications.

Cost Share Options

1. **Standard Producer (35% Cost Share)** - Each program offers cost share at this level.
2. **Master Producer (50% Cost Share)** - Producers must complete a course related to their operations to be eligible for 50% cost share. **Course must be completed by the applicant prior to program reimbursement deadline.**

The following courses are eligible under this year's program: Master Beef Producer (**MBP**), Master Meat Goat Producer (**MMGP**), Master Bee Hobbyist (**MBH**), and three or more Tennessee Quality Milk Initiative (**TQMI**) modules.

- **Cattle Genetics** - cattle producers taking MBP or TQMI
- **Livestock Equipment** - cattle or goats/sheep producers taking MBP, MMGP or TQMI
- **Hay Storage** - cattle, goats/sheep, or hay producers taking MBP, MMGP or TQMI
- **Livestock Feed Storage** - cattle or goats/sheep producers taking MBP, MMGP or TQMI
- **Producer Diversification** - beekeepers taking MBH course

Visit www.utextension.utk.edu to find local UT Extension information about educational certifications.

TDA offers partial scholarships for participation in UT Extension's MBP, MMGP, MBH and/or TQMI programs. Funding is paid directly to UT.

- Master Beef Producer Scholarship - \$100
- Master Meat Goat Producer Scholarship - \$100
- Master Bee Hobbyist Scholarship - \$50
- TQMI Module - \$40 per session

Rules

Application Rules

1. Applications must be postmarked June 1-7, 2011 or hand delivered during the same period.
 - Faxed or emailed applications will not be accepted.
 - Applications postmarked or hand delivered prior to June 1, 2011 and after June 7, 2011 are ineligible.
2. Application A (Cattle Genetics, Livestock Equipment, Hay Storage, Livestock Feed Storage, and Grain Storage) cost share requests are processed on a first come, first served basis.
3. Application B (Producer Diversification) cost share requests are evaluated on a competitive basis by industry sector.
4. Applicants may only submit one Application A per premises or property, per household, per business, per application period.
5. Applicants may only submit one Application B per premises or property, per household, per business, per application period.
6. Applicant will be notified in writing of approval or disapproval. Allow 10 weeks for application processing.

Reimbursement Rules

1. Receipts/payments dated prior to June 1, 2011 are not eligible.
2. Cash receipts or receipts for in-kind services are not eligible.
3. Used equipment or used materials are not eligible for cost share reimbursement.
4. Labor provided by applicant or their employees is not eligible for cost share reimbursement.
5. Applicant cannot be reimbursed for purchases from a business where applicant participates in ownership (producer cooperatives excluded).
6. Applicants cannot combine projects with other applicants.
7. Proof of payment is required in the form of cancelled check copies (bank provided copies are acceptable), cashier's check, money order or credit receipt.
8. Reimbursement documentation must be postmarked or hand delivered by the reimbursement deadline. Allow 10 weeks for processing. Additional processing time is required for incomplete reimbursement requests and requests submitted within one month of the program deadline.
9. Minimum cost share reimbursement request is \$250 per program.
10. There can only be one **reimbursement** payment per cost share approval. All projects must be completed **before** submitting reimbursement documentation.
11. Failure to complete projects and utilize allocated funds can affect eligibility for future program participation.
12. Falsifying applications, invoices or other documents submitted to TDA may make producer and farm ineligible to participate in present and/or future TDA programs, and may result in civil litigation or criminal prosecution.

Verification Rules

1. Applicant must utilize equipment and structures purchased with cost share funds for the intended purpose of the program for a **minimum of three continuous years from date of purchase**.
2. Site visits relating to the performance of the activity before, during and after completion may take place.
3. Applicants may be required to repay funds if they fail to comply with all aspects of the cost share guidelines.

TAEP Reserves the Right to:

- Reject any or all requests.
- Modify program criteria, approval and payment processes.
- Provide partial funding for specific activity components that may be less than the full amount requested.
- Require additional information from the applicant.
- Deny payments for projects that do not meet requirements.

TAEP APPLICATION A – Quick Reference for 2011 Program Requirements

Producer Type	Cattle Genetics \$1,200 Max	Livestock Equipment \$3,500 Max	Hay Storage \$7,500 Max	Livestock Feed Storage \$10,000 Max	Grain Storage \$15,000 Max
Cattle <i>Beef/Dairy</i>	<ul style="list-style-type: none"> •30 Head min. •Owned or leased land •Premises ID •BQA •Standard = 35% •MBP or TQMI = 50% 	<ul style="list-style-type: none"> •30 Head min. •Owned or leased land •Premises ID •BQA •Standard = 35% •MBP or TQMI = 50% •Permit - Dairy 	<ul style="list-style-type: none"> •30 Head min. •Land ownership required •Premises ID •BQA •Standard = 35% •MBP or TQMI = 50% •Project quote(s) 	<ul style="list-style-type: none"> •100 Head min. •Land ownership – sheds & silos •Premises ID •BQA •Standard = 35% •MBP or TQMI = 50% •Permit - Dairy •Project quote(s) & diagrams 	
Goats/Sheep <i>Meat/Dairy</i>		<ul style="list-style-type: none"> •50 Head min. (combined) •Owned or leased land •Premises ID •Standard = 35% •MMGP or TQMI = 50% •Permit - Dairy 	<ul style="list-style-type: none"> •50 Head min. (combined) •Land ownership required •Premises ID •Standard = 35% •MMGP or TQMI = 50% •Project quote(s) 	<ul style="list-style-type: none"> •150 Head min. (combined) •Land ownership – sheds & silos •Premises ID •Standard = 35% •MMGP or TQMI = 50% •Permit - Dairy •Project quote(s) & diagrams 	
Hay			<ul style="list-style-type: none"> •50 Acres of hay production •Land ownership required •Premises ID if livestock present •Standard = 35% •MBP or MMGP = 50% •Project quote(s) 		
Poultry <i>Broilers</i>				<ul style="list-style-type: none"> •10,000/yr min. •Land ownership – sheds & silos •Premises ID •Standard = 35% •Project quote(s) & diagrams 	
Poultry <i>Layers</i>				<ul style="list-style-type: none"> •5,000/yr min. •Land ownership – sheds & silos •Premises ID •Standard = 35% •Project quote(s) & diagrams 	
Swine				<ul style="list-style-type: none"> •100 Head min. •Land ownership – sheds & silos •Premises ID •Standard = 35% •PQA Plus •Project quote(s) & diagrams 	
Grain					<ul style="list-style-type: none"> •100 Acres in row crop production •Land ownership - bins & permanent equipment •Premises ID if livestock present •Standard = 35% •Project quote(s)
Abbreviations	<p>BQA=Beef Quality Assurance MBP=Master Beef Producer PQA=Pork Quality Assurance TQMI=TN Quality Milk Initiative MMGP=Master Meat Goat Producer</p> <p>Head of livestock refers to actual number of a single type regardless of sex or age, at application date. Goats/Sheep can be combined to meet min. number requirement.</p> <p>Land ownership refers to the property where permanent structures will be built. Projects must be built or installed on land located in TN.</p>				

Application Period Closed

A. Cattle Genetics

Livestock Minimum Requirements	Property	Premises Registration	Certifications	Cost Share \$1,200 Maximum	
Cattle - 30 Head	Owned or Leased	Required	BQA - Beef and Dairy	Standard 35%	Master 50%

PROGRAM GOALS: Increase the marketability, longevity and reputation of Tennessee's cattle

GUIDELINES use application A, pages 15 and 16 to apply

Eligible Items

- | | |
|--|--|
| <ol style="list-style-type: none"> 1. Bulls (natural service) <ol style="list-style-type: none"> a. Purchased bulls - ownership must be maintained for a min. of two successive 90 day breeding seasons - not in the same year b. Leased bulls - terms of lease - min. of 60 days up to one year <ul style="list-style-type: none"> • Max. lease reimbursement - \$400 2. Artificial Insemination (AI) <ol style="list-style-type: none"> a. Semen tanks b. Purchase of semen from eligible AI sires <ul style="list-style-type: none"> • Semen packages - max. reimbursement \$15 per straw | <ol style="list-style-type: none"> c. Supplies <ul style="list-style-type: none"> • Synchronization • Heat detection - <i>computerized systems not eligible</i> • AI kit, contents and sanitation supplies • Liquid nitrogen fills d. AI technician fees - <i>mileage not eligible</i> e. AI training certification - max. reimbursement \$200 3. Testing - <i>mileage not eligible</i> <ol style="list-style-type: none"> a. Breeding soundness evaluation (BSE) b. Pregnancy testing c. EID tags - only for cattle being tested |
|--|--|

Requirements

Expected Progeny Differences (EPD's) and Lifetime Net Merit (LNM) have changed for this application period. Breed eligibility criteria will be posted online by June 1, 2011 at www.TN.gov/agriculture/enhancement and will be included in producer approval packet.

- | | |
|---|---|
| <ol style="list-style-type: none"> 1. Beef - AI and/or natural service bulls must meet or exceed the min. requirements for one of the following three bull types: <ol style="list-style-type: none"> a. Balanced bulls (balance of good calving ease, growth and maternal) b. Terminal bulls (improved growth with acceptable calving ease; maternal not required) c. Heifer bulls (improved calving ease with acceptable growth and maternal) <p>Each bull type (Balanced, Terminal or Heifer bull) has a different set of EPD requirements - The required set of EPD's must be met for each of the following three EPD trait categories:</p> <ul style="list-style-type: none"> • Calving ease (CE <u>or</u> BW) • Growth (WW <u>or</u> YW) • Maternal (Milk range) <p>EPD values must be current as of June 1, 2011 to be eligible for reimbursement</p> 2. Dairy - AI and/or natural service bulls must meet or exceed the min. requirements for one of the following two trait categories <ol style="list-style-type: none"> a. Lifetime Net Merit (LNM) b. Breed index (ex. TPI for Holstein / JPI for Jersey)
LNM or Index values must be current as of June 1, 2011 to be eligible for reimbursement 3. Breeding Soundness Evaluation (BSE) <ol style="list-style-type: none"> a. Bulls must pass a BSE - certificate from a licensed veterinarian must be included with reimbursement request b. BSE must be dated within 90 days of purchase or reimbursement request | <ol style="list-style-type: none"> 4. Electronic Identification (EID) - 15 digit number <ol style="list-style-type: none"> a. Producer will identify bull with an electronic identification tag and provide number to TDA b. Tags can be purchased at most farm supply stores or local veterinarian 5. Artificial Insemination (AI) <ol style="list-style-type: none"> a. Cost of AI technicians or Tennessee licensed veterinarian fees are eligible - AI technicians must be certified by an accredited AI company b. Producers certified to do AI through an accredited program (e.g., Genex, ABS or Select Sires, etc) can do their own AI work - <i>Producer labor is not reimbursable</i> 6. AI Certification <ol style="list-style-type: none"> a. Training must be sponsored by an AI company that is a member of the National Association of Animal Breeders (NAAB) and follows the recommended guidelines b. Min. of two days training required - part of which must be in a classroom environment 7. Testing <ol style="list-style-type: none"> a. BSE & pregnancy testing - must be performed by a Tennessee licensed veterinarian b. Animals must be officially identified in one of the following ways: EID, 840 or USDA metal tag, or a unique brand or tattoo c. Veterinarian testing report with individual animal ID must be submitted for reimbursement |
|---|---|

Ineligible Items

- | | |
|--|--|
| <ol style="list-style-type: none"> 1. Producer time and labor for AI work will not be reimbursed 2. Embryo transfer 3. Herd evaluation 4. AI registration certificates | <ol style="list-style-type: none"> 5. Mileage, transportation and delivery expenses 6. Computerized heat detection systems 7. Carcass ultrasounding |
|--|--|

B. Livestock Equipment

Livestock Minimum Requirements	Property	Premises Registration	Certifications	Cost Share \$3,500 Maximum	
Cattle - 30 Head Goats/Sheep - 50 Head	Owned or Leased	Required	BQA - Beef and Dairy Permit - Dairy	Standard 35%	Master 50%

PROGRAM GOALS: Improve long term livestock husbandry and management capabilities and enhance farm safety

GUIDELINES use application A, pages 15 and 16 to apply

A. Eligible Items *Dairy, Beef, Goats/Sheep*

<ol style="list-style-type: none"> 1. Head gate 2. Squeeze chute (concrete to level)* 3. Palpation cage 4. Single animal scale (concrete to level)* 5. Multiple animal scale (concrete to level)* Scales used for commerce must be state certified 6. Hoof trimming table or chute 7. Hay ring and/or cone insert 8. Slant bar hay feeding wagon 9. Feed bins and/or unload augers - min. bin capacity/4 dry tons including concrete pad to level* - labor, setup, installation and delivery are not eligible 10. Creep feeder and/or panels 11. Bunk feeders-concrete formed and/or steel (concrete to level)* plastic not eligible 12. Automatic cube pellet feeders 13. EID, portable and/or panel readers 14. Tubular gates and/or portable corral panels - for Livestock Management use only 	<ol style="list-style-type: none"> 15. Holding chute/alleyway 16. Crowding tub system 17. Loading chute 18. Curved or offset working chute 19. Holding pen (or hospital pen) <ol style="list-style-type: none"> a. Requirements <ul style="list-style-type: none"> • Securely attached to a handling, working or loading system • Completely enclosed perimeter - stand alone sides not eligible - see Ineligible item 7. • Maximum size: 30,000 sq. ft. • Holding pen and hospital pen plans are available at county UT Extension offices 	<p>(Items 15 - 19) Working system guidelines</p> <ul style="list-style-type: none"> • Must conform to the individual item description & requirements • Eligible components and materials include: <ul style="list-style-type: none"> ◦ Item #14 ◦ Alley panels ◦ Wire stockade or bull panels (1 to 6 gauge) ◦ Lumber - boards and/or posts ◦ Metal posts - includes I-beams, piping and/or T-posts ◦ Concrete for setting posts*
---	--	--

B. Dairy Only Items *Dairy producers can also purchase items listed in section A*

<ol style="list-style-type: none"> 1. Headlock and/or dairy stanchions and palpation rails 2. Commercial water heater¹ 3. Water sterilization equipment 4. Plate exchanger for cooling 	<ol style="list-style-type: none"> 5. Milk vacuum pump 6. Milker pulsation equipment 7. Vacuum system regulators 8. Vacuum gauges 9. Milk pipeline system² 	<ol style="list-style-type: none"> 10. Milking equipment service contract³ 11. Antibiotic test kits for on farm use⁴ 12. Milk quality lab analyses
---	--	---

C. Goats/Sheep Only Items *Goats/Sheep producers can also purchase items in section A*

<ol style="list-style-type: none"> 1. Kidding/lambing pen, max. size per pen, 144 sq. ft. (12x12) 	<ol style="list-style-type: none"> 2. Fitting stand/hoof trimming table or chute 	<ol style="list-style-type: none"> 3. Tilt/roll table
--	---	--

Ineligible Items

<ol style="list-style-type: none"> 1. Used equipment and used materials 2. Labor of any type 3. Material and labor for the installation of electrical service to bins or equipment 4. Fuel 5. Delivery charges 6. Overhead coverings or roofing materials for working facilities/equipment 7. Woven wire, barbed wire, high tensile, electric fence, or any stand alone fences 	<ol style="list-style-type: none"> 8. Tanks 9. Liquid handling systems 10. Watering systems, fencing and high traffic areas - contact the Soil Conservation District office in your county to apply for cost share assistance on these practices 11. Concrete, except where noted by (*) 12. Gravel 13. Geotextile 14. Ear tags, taggers or software 	<ol style="list-style-type: none"> 15. Hoof trimmers 16. Hay un-rollers 17. Plastic feed bunks/troughs 18. Gravity wagons 19. Mineral feeders 20. Semen tanks - now eligible in cattle genetics (page 5) 21. Guard rails 22. Fans 23. Calf hutches
---	---	---

¹ Water heaters must be capable of maintaining a water temperature of 165 degrees
² Includes but not limited to automatic washer/sanitizing unit, clean in-place unit, washers, milker claws (units), vertical wash vat

³ Milking equipment service contracts must be no longer than a 12 month period
⁴ Cow-side tests including incubator or heater block and test kits

* Concrete allowed on these items only, labor is not included

Livestock Equipment Example

This diagram is printed to illustrate EXAMPLES of eligible items and components in a livestock handling system.

Consulting livestock industry professionals and producers is encouraged when developing a plan for your livestock handling system. Plans are also available at county UT Extension offices or at <http://bioengr.ag.utk.edu/Extension/ExtPubs/PlanList97.htm#Beef Plans>.

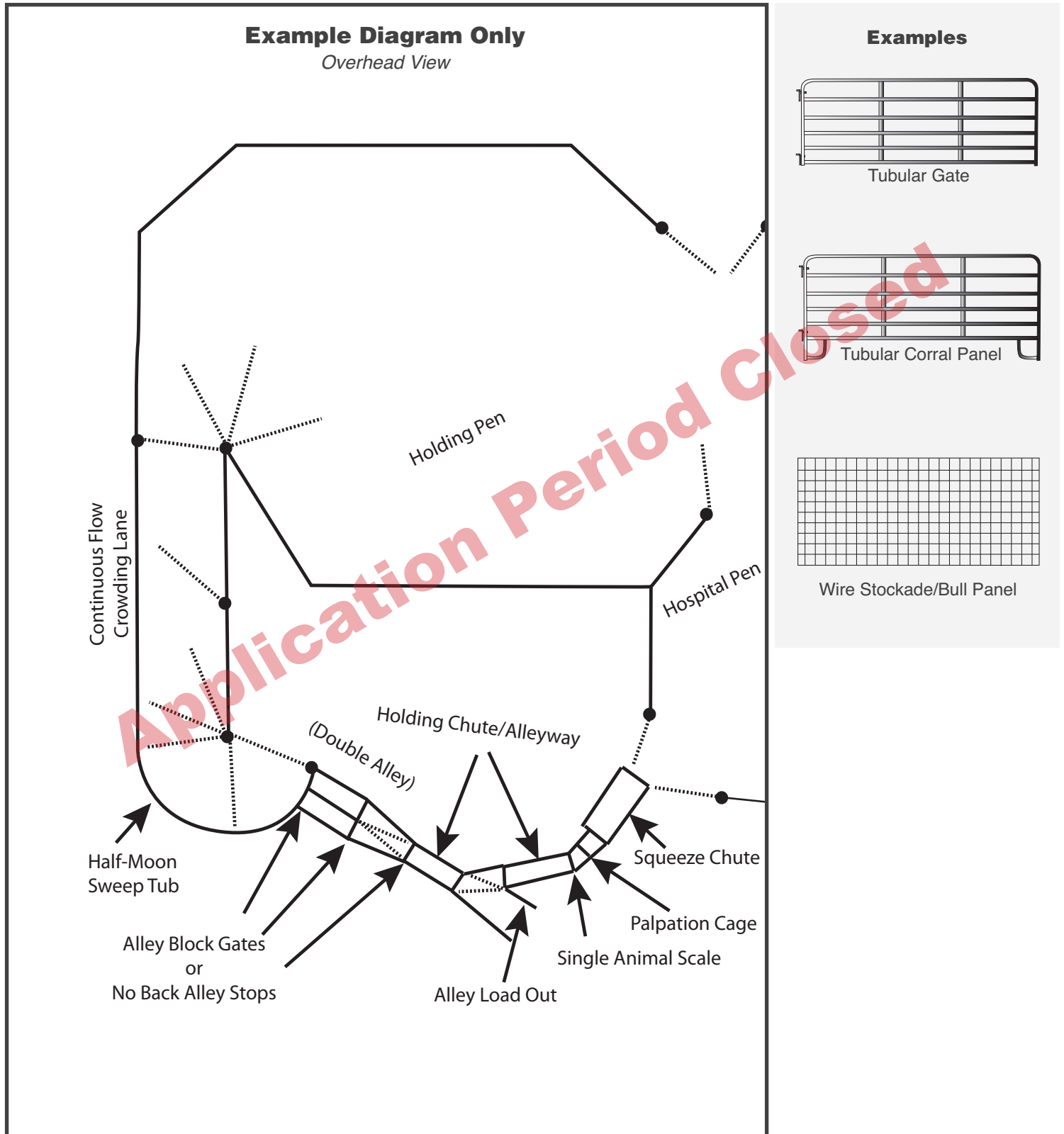

C. Hay Storage

Livestock/Acreage Minimum Requirements	Property	Premises Registration	Certifications	Cost Share \$7,500 Maximum		Cost Quote
				Standard	Master	
Cattle - 30 Head Goats/Sheep - 50 Head Hay - 50 Acres	Applicant Owned	Required for livestock producers	BQA - Beef and Dairy	35%	50%	Required

PROGRAM GOALS: Improve quantity and nutritional quality by using proper storage and management

GUIDELINES use application A, pages 15 and 16 to apply

Eligible Items

1. New structures and additions to existing structures with no more than three walls
 - a. New structures must be a min. of 900 sq. ft. - loft or 2nd level will not be considered in total sq. ft. of structure
 - b. Min. eave height - 14 ft. high clearance for new structures and additions
 - c. Use of structure must be for hay storage only
2. Site Preparation - site must be well drained; cost of elevated pad construction is eligible, *clearing of land is not eligible*
3. Roof - metal, shingles, or a polymer coated fabric (e.g., Cover- All, Clear Span, Super Structure, etc.)
4. Flooring - recommended but not required; 4- 6 inches of gravel on geotextile fabric is eligible for cost share
5. Labor conducted by a contractor - **reimbursement for labor cannot exceed 30% of total reimbursement** - *labor provided by applicant or their employees is not eligible*

Requirements *additional requirements page 9*

1. Application must include a project budget with a COST QUOTE from each vendor.
 - Material and labor costs must be separated on quote.
 - Each cost quote needs to include the name, address and phone number of contractor or supplier.
 - Cost quotes must be on company letterhead or signed by company representative. The budget provided will determine the exact amount of cost share allocated for the project. See Project Budget Work Sheet (page 13).
2. Hay storage structures must conform to the minimum requirements and guidelines of the University of Tennessee Extension Service. These guidelines are available at county UT Extension offices or online at www.TN.gov/agriculture/enhancement under Hay Storage.
3. Hay storage structures must be built on applicant owned land.

Ineligible Items

1. Cost of clearing land
2. Renovations of existing structures
3. Labor provided by applicant or their employees
4. Concrete flooring
5. Completely enclosed buildings - no more than three walls
6. Doors - walk through and drive through
7. Used materials are not eligible for reimbursement



Hay Storage Examples

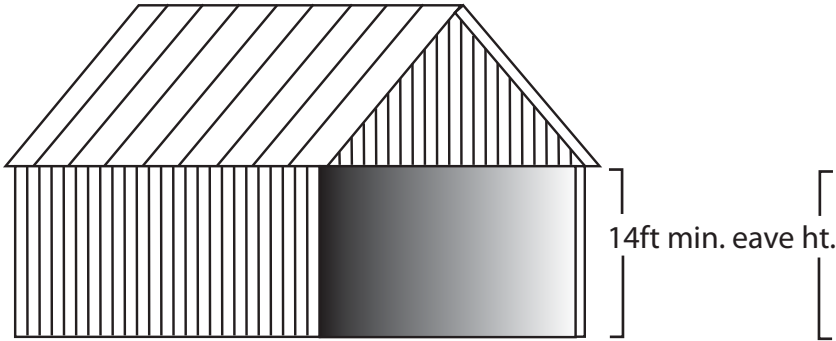

New Structure

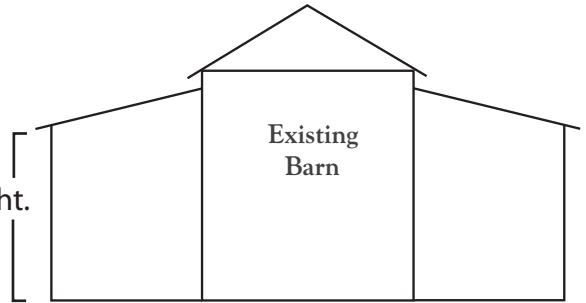

Additions to existing structure

Minimum Size - 900 sq. ft., *new structures only*
length (ft.) x width (ft.) = sq. ft.

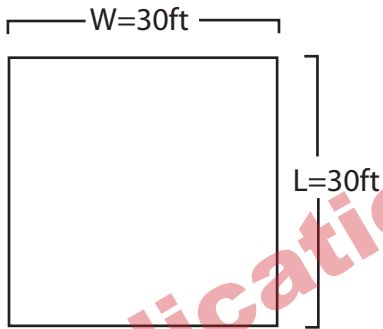

Example: 30 ft. x 30 ft. = 900 sq. ft.



Application Period Closed

Completely enclosed buildings are not eligible.

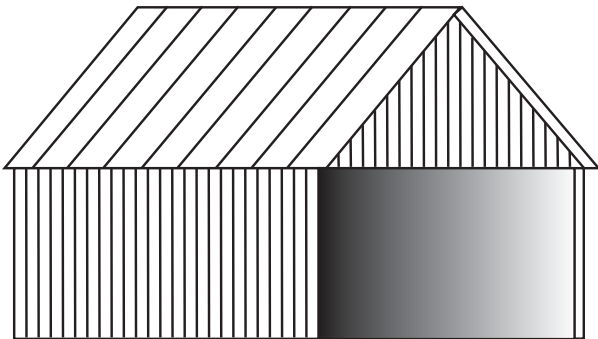

At least one side/end must be completely open.



D. Livestock Feed Storage

Livestock/Acreage Minimum Requirements	Property	Premises Registration	Certifications	Cost Share \$10,000 Maximum		Cost Quote
				Standard 35%	Master 50%	Required Diagram Commodity sheds
Cattle - 100 Head Goats/Sheep - 150 Head Broilers - 10,000/yr Layers - 5,000/yr Swine - 100 Head	Applicant Owned - commodity sheds and silos	Required	BQA - Beef and Dairy PQA Plus - Swine Permit - Dairy	Standard 35%	Master 50%	Required Diagram Commodity sheds

PROGRAM GOALS: Improve long term feed storage, cost efficiency and feed quality

GUIDELINES use application A, pages 15 and 16 to apply

Eligible Items

- Mixer wagons and grinder/mixers - equipment directly used to mix and/or grind hay, grain and other supplements for feed
- Hay wrappers - machinery used for the wrapping of hay for use as haylage
- Commodity shed - new structures and additions to existing structures used for storage of bulk raw commodities, including whole grains and co-products used in a mixing process to produce feed (see page 11 for min. requirements)
- Silage baggers - machinery used for the bagging or debagging of silage
- Silos - ground and upright for storage of silage
- Labor - labor conducted by a contractor, or the supplier for construction of infrastructure and installation of new equipment; **reimbursement for labor cannot exceed 30% of total reimbursement - labor provided by the applicant or their employees is not eligible**

Dairy Only Items

- Stationary milk tanks
- Generators for dairy barn

Poultry and Swine Only Items

- Generators for poultry or swine barn
- Feed bin that has a minimum capacity of 4 tons and its only purpose is for on farm storage of animal feed

Requirements additional requirements page 11

- Application must include a project budget with a **COST QUOTE** from each vendor.
 - Material and labor costs must be separated on quote.
 - Each cost quote needs to include the name, address and phone number of contractor or supplier.
 - Cost quotes must be on company letterhead or signed by company representative. The budget provided will determine the exact amount of cost share allocated for the project. See Project Budget Work Sheet (page 13).
- Commodity shed quotes must include blueprint, floor plan, or detailed drawing of proposed shed.** Blueprint, floor plan, or drawing must show that quoted structure meets all minimum specifications.
- Applicants cannot be reimbursed for the same type of equipment or item in two consecutive program years.
- Commodity sheds and silos must be built on applicant owned land.

Ineligible Items

- Feed bins for cattle and goats/sheep, see Livestock Equipment (page 6)
- Bins that will be used for storage of bulk commodities not directly used for feed
- Skid steers and attachment implements for existing equipment
- Plastic used in bagging or wrapping procedures
- Grain elevators or other equipment used to load or unload bins or silos
- Grain/gravity wagons
- Commodity sheds used for storage of materials other than bulk raw commodities (e.g., hay and commercial mixed feeds)
- Renovations of existing structures and equipment
- Used equipment and used materials
- Labor provided by applicant or their employees
- Completely enclosed commodity sheds - no more than three exterior walls
- Doors - walk through and drive through
- Material and labor for the installation of electrical service to equipment



Commodity Shed Examples

Minimum Specifications

1. No more than three EXTERIOR walls, *completely enclosed buildings are not eligible*
2. Structure must have at least four reinforced INTERIOR walls, 4 ft. min. ht.
3. Minimum 14 ft. concrete apron
4. Bays - two or more
5. Concrete floor
6. Minimum 960 sq. ft.
7. Minimum height requirements:
 - Monoslope Roof - 18 ft. front
 - Gable Roof - 16 ft.

Minimum Size 960 sq. ft. TOP VIEW

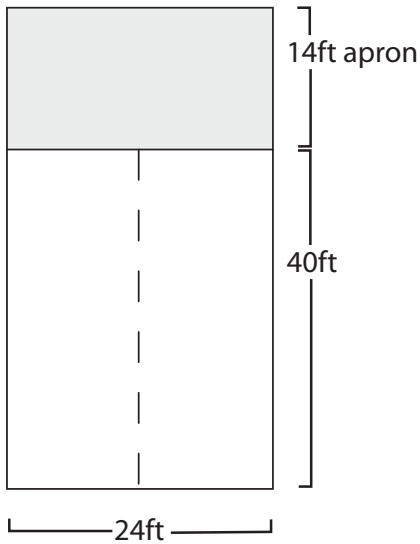

length (40 ft.) x width (24 ft.) = 960 sq. ft.

UT Plan T4138*

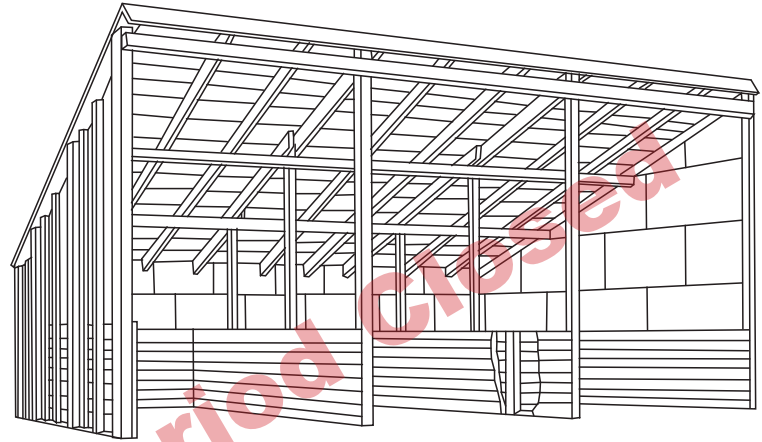

*<http://Bioengr.ag.utk.edu/extension/extpubs/plans/T4138.pdf>

Monoslope Roof

SIDE VIEW

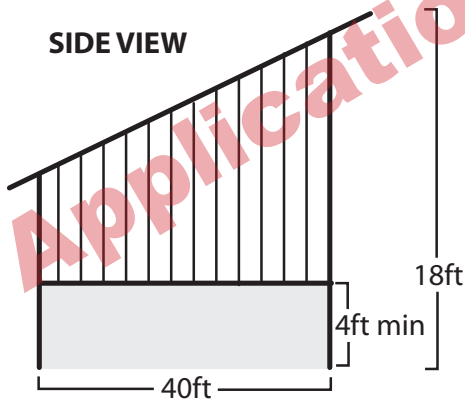

FRONT VIEW

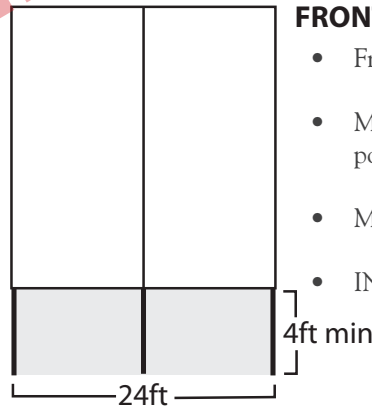

- Front - must be completely open
- Monoslope roof with reinforced walls, poured concrete or boards/planks
- Minimum of two bays
- INTERIOR Walls must be a min of 4 ft. high

Gable Roof

SIDE VIEW

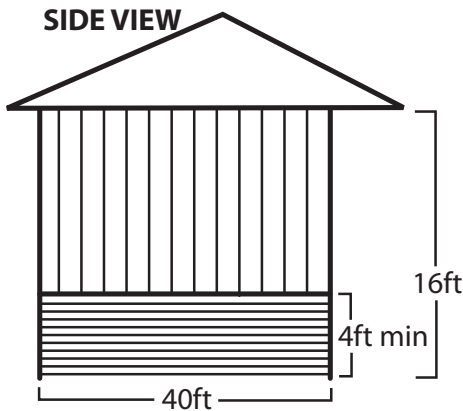

FRONT VIEW

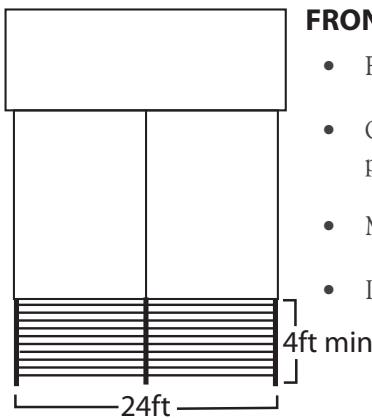

- Front - must be completely open
- Gable roof with reinforced walls, poured concrete or boards/planks
- Minimum of two bays
- INTERIOR Walls must be a min of 4 ft. high

E. Grain Storage

Acreage Minimum Requirements	Property	Premises Registration	Cost Share \$15,000 Maximum	Cost Quote
100 Acres in row crop production	Applicant Owned - bins and permanent equipment	Required for livestock producers	Standard 35%	Required

PROGRAM GOALS: Improve quantity, quality and marketing through proper storage and management

GUIDELINES use application A, pages 15 and 16 to apply

Eligible Items

- | | |
|---|--|
| <ol style="list-style-type: none"> 1. New permanent bins - min. capacity of 10,000 bushels per bin 2. New permanently affixed equipment and accessories, necessary for proper and safe handling of grain, including drying and aeration components, conveyors and bin unload augers 3. Labor conducted by a contractor or the supplier for the construction of new bins and installation of new equipment - reimbursement for labor cannot exceed 30% of total reimbursement - labor provided by the applicant or their employees is not eligible | <ol style="list-style-type: none"> 4. Portable bagging system 5. Grain vacuum 6. Transport auger 7. Site preparation <ol style="list-style-type: none"> a. concrete foundations b. aprons c. pads d. associated labor and materials for construction of new bins and/or equipment |
|---|--|

Requirements

- | | |
|--|--|
| <ol style="list-style-type: none"> 1. Application must include a project budget with a COST QUOTE from each vendor. <ul style="list-style-type: none"> • Material and labor costs must be separated on quote. • Each cost quote needs to include the name, address and phone number of contractor or supplier. • Cost quotes must be on company letterhead or signed by company representative. The budget provided will determine the exact amount of cost share allocated for the project. See Project Budget Work Sheet (page 13). | <ol style="list-style-type: none"> 2. Bins and permanent equipment must be built on applicant owned land. |
|--|--|

Ineligible Items

- | | |
|--|---|
| <ol style="list-style-type: none"> 1. Grain/gravity wagons 2. Material and labor for the installation of electrical service to bins or equipment 3. Plastic used in bagging | <ol style="list-style-type: none"> 4. Labor provided by applicant or their employees 5. Any grain bin or grain handling equipment for commercial purposes 6. Addition of rings to existing bins to increase capacity 7. Used bins, equipment and used materials |
|--|---|



Project Budget Worksheet

Producer Name:

Circle Program Worksheet Applies To:

One worksheet per program – please make copies if applying for more than one program

Livestock
Feed Storage

Hay Storage

Grain Storage

Cost Quotes Must:	Costs To Remember When Preparing Quote:
<ol style="list-style-type: none"> 1. Be on company letterhead or signed by a company representative 2. Include name, address and phone number of vendor 3. Separate material and labor costs 4. Include blueprint, floor plan or detailed drawing (commodity sheds only) 	<ol style="list-style-type: none"> 1. Site preparation 2. Gravel 3. Geotextile fabric

ACTUAL PROJECT BUDGET

Item Description <i>Length, Width, Height</i>	Source of Cost Quote <i>Include Vendor Contact Info</i>	Cost	Cost Share %	Cost Share Request

Total Amount of Cost Share Requested: \$

1. Include all items/activities necessary to complete project
2. MUST attach copy of written cost estimate from vendor for each item listed above
3. Include contact information for source of cost quotes



REQUIRED FOR APPLICATION A APPROVAL
Cattle Genetics, Livestock Equipment, Hay Storage, Livestock Feed Storage, Grain Storage

SUBSTITUTE W-9 FORM
REQUEST FOR TAXPAYER IDENTIFICATION NUMBER AND CERTIFICATION

1. Please complete general information:

Taxpayer Name _____ Phone Number _____

Business Name (if applicable) _____

Address _____

City _____ State _____ ZIP Code _____

Reimbursement check will be mailed to this address.

2. Circle the most appropriate category below: (please circle only one)

- 1) Individual (not an actual business)
- 2) Joint account (two or more individuals)
- 3) Custodian account of a minor
- 4)
 - a. Revocable savings trust (grantor is also trustee)
 - b. So-called trust account that is not a legal or valid trust under state law
- 5) Sole proprietorship (using a social security number for the taxpayer ID)
- 6) Sole proprietorship (using a federal employer identification number for taxpayer ID)
- 7) A valid trust, estate, or pension trust
- 8) Corporation
- 9) Association, club, religious, charitable, educational, or other non-profit organization (for entities that are exempt from federal tax, use category 13 below)
- 10) Partnership
- 11) A broker or registered nominee
- 12) Account with the US Department of Agriculture in the name of a public entity that receives agricultural program payments
- 13) Government agencies and organizations that are tax-exempt under Internal Revenue Service guidelines (i.e., IRC 501(c)3 entities)

3. Fill in your taxpayer identification number below: (please complete only one)

- 1) If you circled number 1-5 above, fill in your Social Security Number.**

____ - ____ - _____

- 2) If you circled number 6-13 above, fill in your Federal Employer Identification Number (EIN).**

____ - _____

4. Sign and date the form:

Certification - Under penalties of perjury, I certify that the number shown on this form is my correct taxpayer identification number. If I circled category 13 above, I also certify that my agency or organization is tax-exempt per Internal Revenue Service guidelines and not subject to backup withholding.

Signature _____ Date _____

Title (if applicable) _____



2011 TAEP COST SHARE – APPLICATION A

Office Use Only – Date Received:

1. APPLICANT INFORMATION

Taxpayer ID Information List only one number		Social Security Number (XXX-XX-XXXX)		Federal Tax ID# (XX-XXXXXXX)	
Last Name		First Name		M.I.	Title <input type="checkbox"/> MR <input type="checkbox"/> MRS <input type="checkbox"/> JR <input type="checkbox"/> MS <input type="checkbox"/> MISS <input type="checkbox"/> SR
Address Info		Street	City	ST	Zip Code
Mailing				TN	
Residential				TN	
Home Phone		Cell Phone		E-mail	

2. FARM/PREMISES INFORMATION

- TDA Premises Registration is required if applicant has livestock on their operation. Applicant name must match contact name (primary or alternate) listed on premises account to be eligible.
- List the premises information, property ownership and farm address of your project.
- If you do not have livestock on your operation, write n/a in the premises boxes, list farm address and indicate property ownership.

Premise Account #	Premise ID #	Property Ownership <input type="checkbox"/> I own <input type="checkbox"/> I lease			
Farm Address of TAEP Project					
Street	City	ST	Zip Code	County	
		TN			

Farm address must match address registered for Premises ID # listed above.

3. APPLICANT CERTIFICATIONS/PERMITS

- Certification/permits must be completed by the applicant. No substitutions, such as farm managers or relatives, are allowed.

BEEF CATTLE PRODUCERS			
Tennessee Beef Quality Assurance (BQA) – Required to apply Renewed every two years. Must be current at time of application.	Certification #:	Expiration Date:	
UT Master Beef Producer (MBP) – Required only for 50% Course must be completed prior to reimbursement deadline.	Year Completed:	Where/County:	
	Plan to attend?	<input type="checkbox"/> No <input type="checkbox"/> Yes	

DAIRY CATTLE PRODUCERS			
Tennessee Beef Quality Assurance (BQA) – Required to apply Renewed every two years. Must be current at time of application.	Certification #:	Expiration Date:	
TDA Dairy Permit # - Required to apply Dairies must be permitted by TDA to be eligible as a dairy under TAEP.	Permit #		
UT Quality Milk Program (TQMI) – Required only for 50% Course must be completed prior to reimbursement deadline. Must complete three or more modules to be eligible for 50%.	Year Completed:	Where/County:	
	Plan to attend?	<input type="checkbox"/> No <input type="checkbox"/> Yes	

GOAT PRODUCERS			
UT Master Meat Goat Producer (MMGP) – Required only for 50% Course must be completed prior to reimbursement deadline.	Year Completed:	Where/County:	
	Plan to attend?	<input type="checkbox"/> No <input type="checkbox"/> Yes	

SWINE PRODUCERS			
Pork Quality Assurance Plus (PQA) – Required to apply Renewed every three years. Must be current at time of application.	Certification #:	Expiration Date:	

Application A general instructions are available online at www.tn.gov/agriculture/enhancement or from your local extension office.

4. LIVESTOCK AND ACREAGE INFORMATION

- Check type of livestock/acreage on your operation. List number of head/acreage.
- Head of livestock refers to the actual number of a single type regardless of sex or age, at date of application.
- Goats/Sheep can be combined to meet minimum number requirement.

Livestock Type	# of Head	Livestock Type	# of Head	Acreage Type	# of Acres
<input type="checkbox"/> Cattle - Beef		<input type="checkbox"/> Poultry - Broilers		<input type="checkbox"/> Hay	<i>List total # of acres in row crop production:</i>
<input type="checkbox"/> Cattle - Dairy - Milk producer		<input type="checkbox"/> Poultry - Layers		<input type="checkbox"/> Corn	
<input type="checkbox"/> Cattle - Dairy - Heifer replacement		<input type="checkbox"/> Sheep - Meat		<input type="checkbox"/> Soybeans	
<input type="checkbox"/> Goats - Meat		<input type="checkbox"/> Sheep - Dairy		<input type="checkbox"/> Wheat	
<input type="checkbox"/> Goats - Dairy		<input type="checkbox"/> Swine		<input type="checkbox"/> Other	

5. COST SHARE REQUEST SUMMARY

- Indicate your cost share request per program.

Program	Cost Share Request Summary √ Check box to indicate your request per program		Office Use Only
Cattle Genetics \$1,200 Max.	<input type="checkbox"/> No	<input type="checkbox"/> Yes	<input type="checkbox"/> A <input type="checkbox"/> D
Livestock Equipment \$3,500 Max.	<input type="checkbox"/> No	<input type="checkbox"/> Yes	<input type="checkbox"/> A <input type="checkbox"/> D
Hay Storage \$7,500 Max.	<input type="checkbox"/> No	<input type="checkbox"/> Yes – additional materials required: • Project budget cost quotes required • Budget will determine exact allocation amount	<input type="checkbox"/> A = <input type="checkbox"/> D
Livestock Feed Storage \$10,000 Max.	<input type="checkbox"/> No	<input type="checkbox"/> Yes – additional materials required: • Project budget cost quotes required • Budget will determine exact allocation amount • Commodity sheds also require a diagram	<input type="checkbox"/> A = <input type="checkbox"/> D
Grain Storage \$15,000 Max.	<input type="checkbox"/> No	<input type="checkbox"/> Yes – additional materials required: • Project budget cost quotes required • Budget will determine exact allocation amount	<input type="checkbox"/> A = <input type="checkbox"/> D

6. APPLICANT AGREEMENT

- I certify that I am a resident of Tennessee and that I am at least 18 years old on application date.
- I have reviewed and understand all of the guidelines listed in this application booklet.
- I certify that all the information on this application is complete, true and factual to the best of my knowledge and belief.
- I understand that providing any false, fraudulent or misleading information may result in penalties and/or make this farm/tract ineligible to participate in present and/or future Tennessee Department of Agriculture programs.
- I understand that the minimum cost share reimbursement request per program is \$250.
- I also understand that failure to utilize allocated funds can affect eligibility for future programs.

Print Applicant Name _____

Date _____

Applicant Signature _____

7. HOW TO SUBMIT "APPLICATION A"

- Review each section of application for completeness.
- Fill in all blanks and check appropriate boxes where requested.
- Attach Substitute W-9 form (page 14).
- Attach cost quotes, project budget worksheet, and diagrams where required.
- NO FAXES OR EMAILS ACCEPTED - Applications are only accepted by mail or hand delivery.

Mail to:
TN Dept. of Agriculture
Attn: TAEP FY2011-A
P.O. 40627
Nashville, TN 37204

Applications must be postmarked June 1 – 7, 2011 or hand delivered during the same period.

Applicant will be notified in writing of approval or denial of application. Allow 10 weeks for processing.

F. Producer Diversification Cost Share

Eligible Industry	Application Proposal	35% Standard Producer	50% Priority Area
Agritourism	Required for all	\$10,000 Max	\$15,000 Max
Fruits and Vegetables			
Honey Bees			
Organics			
Aquaculture	Required for all	\$10,000 Max	Not Available
Horticulture			
Value-Added Products			
Viticulture			

PROGRAM GOALS:

Encourage agricultural producers to expand or improve their operations through the production of diversified agricultural products in these industry sectors: agritourism, aquaculture, fruits and vegetables, honey bees, horticulture, organics, value-added products and viticulture

PRIORITY AREAS - Special Requirements for 50% Cost Share

Agritourism	<p>Must have attended two events from the list below prior to reimbursement deadline. One event MUST be an Agritourism Conference or Direct Marketing Sense Course. A full list of eligible events is available on the TAEP web page at tn.gov/agriculture/enhancement. Use the Producer Program button and follow the links to the Producer Diversification page. The list of eligible events is included in the Agritourism Criteria Sheet.</p> <ul style="list-style-type: none"> • Agritourism Conference (2009, 2010, 2012) • Direct Marketing Sense Course (2010, 2011, 2012) • Agritourism or Direct Marketing Workshop (2009, 2010, 2011) • Agritourism Bus Tour (2009, 2010, 2011) <p>Priority cost share only applies to the purchase of:</p> <ul style="list-style-type: none"> • Brochures • Hand washing stations • Handicap accessible areas • Lighting - public areas • Maps • Parking areas - gravel or pavement • Pavilions - educational • Public address (PA) systems • Restroom facilities • Retail shelters • Safe way areas • Signs • Web site development
Fruits and Vegetables	<p>Must have a viable commercial need for a packing facility for food safety purposes. Wholesale growers that have markets demanding Good Agricultural Practices (GAP) food safety plans will be given priority.</p> <p>Must have attended one of the following workshops from the list below prior to reimbursement deadline. A full list of eligible events is available on the TAEP web page at tn.gov/agriculture/enhancement. Use the Producer Program button and follow the links to the Producer Diversification page. The list of eligible events is included in the Fruits and Vegetables Criteria Sheet.</p> <ul style="list-style-type: none"> • GAP Food Safety Workshop (2010, 2011, 2012) • GAP Mock Audit (2010, 2011) <p>Priority cost share only applies to the purchase of:</p> <ul style="list-style-type: none"> • Produce packing facilities • Food grade materials needed for a GAP plan • Hand washing stations and restroom facilities for workers
Honey Bees	<p>Must complete the UT Master Bee Hobbyist Course prior to reimbursement deadline.</p>
Organics	<p>Must be USDA certified or working towards certification to qualify. Include copy of certification or letter from the certifying agency verifying that you are working towards certification. Producer must be certified at time of reimbursement.</p>

Producer Diversification Guidelines

Application Review Criteria

- The application proposal and budget must be typed in requested format.
- Applications will be evaluated on a competitive basis by industry sector. TDA staff will conduct application reviews.
- Only applications that are complete and include sufficient information will be considered for evaluation.
- The application must merit financial support, clearly state objectives, provide a sound work plan and prove applicant expertise necessary to successfully complete project. An on-site visit or meeting may be required as part of the evaluation process.

Cost Share Project Criteria

Proposed activities for cost share must demonstrate significant potential for increasing farm income through the improvement or expansion of farm or agribusiness operations involving the production of diversified agricultural products. In addition, proposed activities must:

- Be market driven and have a viable marketing plan.
- Establish something new, not maintain on-going projects.
- Meet all state and local food safety and regulatory requirements.
- Produce long term benefits for the farm.
- Encourage future farm growth.

Project Categories

The cost share project may include items from three categories of eligible expenses. The overall project may include items from one or more categories. Some elaborate projects include items from all three categories. Examples of eligible and ineligible items per category are listed below.

FARM INFRASTRUCTURE - Installations that facilitate the production of diversified agricultural products

Infrastructure must be built on applicant owned land located in Tennessee. Activities must have a life span of least three years. Labor is only reimbursable if quoted and performed by a contractor. *Labor is not eligible for reimbursement if performed by the applicant or their employees.*

Eligible Examples	Ineligible Examples
<ul style="list-style-type: none"> • Greenhouses • Retail shelters • Pavilions • Public use considerations – hand washing stations, lighting, parking areas, restroom facilities, safe way areas 	<ul style="list-style-type: none"> • Clearing of land and general landscaping • Fencing • General maintenance/renovations • Barns, storage facilities, show facilities • Permits • Water source creation – ponds or wells

MARKETING - Promotional efforts that benefit the expansion or improvement of diversified agricultural operations.

Emphasis is placed on activities that are innovative to the operation and/or have long term benefits. It is recommended that marketing activities involve professional agencies/services. Trade shows are not eligible for funding unless they are part of a TDA program.

Eligible Examples	Ineligible Examples
<ul style="list-style-type: none"> • Advertising - print, radio, television • Brochures • Direct promotions • E-commerce and Web site development • Maps • Signs 	<ul style="list-style-type: none"> • Community festivals • Give-a-way promotional items • General office equipment and supplies • Trade shows • Web site hosting fees

SPECIALTY EQUIPMENT - Specialized tools or equipment that aids in the production of diversified agricultural products

Items must have a life span of least three years. *Used equipment is not eligible.*

Eligible Examples	Ineligible Examples
<ul style="list-style-type: none"> • Automated harvesters • Chilling units/coolers • Custom crushers • Greenhouse heaters • Spray and irrigation equipment 	<ul style="list-style-type: none"> • General motorized equipment - ATVs, forklifts, golf carts, mowers, tractors, trucks • General inputs - fertilizer, fuel, operational supplies, pesticides, seed stock • Used equipment

Examples of Eligible Cost Share Activity by Industry Sector

Additional cost share activity examples are available at www.TN.gov/agriculture/enhancement, see Producer Programs - Producer Diversification.

Agritourism

- Brochures
- Hand washing stations
- Handicap accessible areas
- Lighting - public areas
- Maps
- Parking areas - gravel or pavement
- Pavilions - educational
- Public address (PA) systems
- Restroom facilities
- Retail shelters
- Safe way areas
- Signs
- Web site development

Aquaculture

- Aerators
- Harvesting equipment
- Ponds (producing)

Honey Bees

- Activity must encompass quality expansion or improvement of pollination or honey production
- Apiaries must be registered with the State of Tennessee
- Minimum requirements include three years beekeeping experience and minimum of five existing colonies
- Eligible Items:
 - Apiary expansion
 - Beehives
 - Honey processing equipment
 - Trailers for pollination service

Fruits and Vegetables

- Apple/peach liners for orchards
- Blackberry/blueberry/raspberry stock
- Freezer
- Greenhouse
- Greenhouse fans and heaters
- Irrigation
- Packing facility
- Plastic mulch layer
- Row covers
- Sprayers
- Walk-in cooler

Horticulture

- Greenhouse
- Greenhouse fan and heater
- Irrigation system
- Packing building
- Packing line equipment
- Potting wagon
- Sprayer

Organics

- Flail mower
- Greenhouse
- Hoop house
- Irrigation
- Roller crimper
- Spader



Application Period Closed

Examples of Ineligible Items

- | | | |
|---|--|---|
| <ul style="list-style-type: none"> • Arena - livestock • Barn - livestock • Building - lodging, show facility, storage • Chemicals/pesticides • Concession stands • Containers - bottles, pots • Drip tape • Driveways • Electrical service bills • Fees - membership, hosting, domain • Fencing • Fertilizer • Fish stock - aquaculture • Fuel | <ul style="list-style-type: none"> • Give-a-way items • General inputs • Ingredients • Labor - applicant or employees of applicant • Landscaping • Land - clearing of • Livestock • Maintenance/renovations of existing structures • Meeting expenses • Merchandise • Motorized equipment/vehicles • Motorized amusement rides • Office equipment/supplies • Permits | <ul style="list-style-type: none"> • Plants • Product development • Property - purchase or debt payment • Rent • Salaries, wages, fringe benefits • Seeds - produce, nursery, flowers, etc. • Software • Trade show expenses • Trailers - livestock • Used equipment • Water source creation - ponds/wells • Winemaking equipment |
|---|--|---|

REQUIRED FOR APPLICATION B APPROVAL
Producer Diversification

SUBSTITUTE W-9 FORM
REQUEST FOR TAXPAYER IDENTIFICATION NUMBER AND CERTIFICATION

1. Please complete general information:

Taxpayer Name _____ Phone Number _____

Business Name (if applicable) _____

Address _____

City _____ State _____ ZIP Code _____

Reimbursement check will be mailed to this address.

2. Circle the most appropriate category below: (please circle only one)

- 1) Individual (not an actual business)
 - 2) Joint account (two or more individuals)
 - 3) Custodian account of a minor
 - 4)
 - a. Revocable savings trust (grantor is also trustee)
 - b. So-called trust account that is not a legal or valid trust under state law
 - 5) Sole proprietorship (using a social security number for the taxpayer ID)
 - 6) Sole proprietorship (using a federal employer identification number for taxpayer ID)
 - 7) A valid trust, estate, or pension trust
 - 8) Corporation
 - 9) Association, club, religious, charitable, educational, or other non-profit organization (for entities that are exempt from federal tax, use category 13 below)
 - 10) Partnership
 - 11) A broker or registered nominee
 - 12) Account with the US Department of Agriculture in the name of a public entity that receives agricultural program payments
 - 13) Government agencies and organizations that are tax-exempt under Internal Revenue Service guidelines (i.e., IRC 501(c)3 entities)
-

3. Fill in your taxpayer identification number below: (please complete only one)

1) If you circled number 1-5 above, fill in your Social Security Number.

_____ - _____ - _____

2) If you circled number 6-13 above, fill in your Federal Employer Identification Number (EIN).

_____ - _____

4. Sign and date the form:

Certification - Under penalties of perjury, I certify that the number shown on this form is my correct taxpayer identification number. If I circled category 13 above, I also certify that my agency or organization is tax-exempt per Internal Revenue Service guidelines and not subject to backup withholding.

Signature _____ Date _____

Title (if applicable) _____



2011 TAEP COST SHARE – APPLICATION B

Office Use Only – Date Received:

1. APPLICANT INFORMATION

Taxpayer ID Information List only one number		Social Security Number (XXX-XX-XXXX)		Federal Tax ID# (XX-XXXXXXX)	
Last Name		First Name		M.I.	Title <input type="checkbox"/> MR <input type="checkbox"/> MRS <input type="checkbox"/> MS <input type="checkbox"/> MISS
					<input type="checkbox"/> JR <input type="checkbox"/> SR
Address Info	Street	City	ST	Zip Code	County
Mailing			TN		
Residential			TN		
Home Phone		Cell Phone (optional)		E-mail (optional)	

2. FARM/PREMISES INFORMATION

- TDA Premises Registration is required if applicant has livestock on their operation. Applicant name must match contact name (primary or alternate) listed on premises account to be eligible.
- List the premises information, property ownership and farm address of your project.
- If you do not have livestock on your operation, write n/a in the premises boxes, list farm address and indicate property ownership.

Premise Account #	Premise ID #	Property Ownership <input type="checkbox"/> I own <input type="checkbox"/> I lease			
Farm Address of TAEP Project					
Street	City	ST	Zip Code	County	
		TN			

Farm address must match address registered for Premises ID # listed above.

3. INDUSTRY SECTOR Indicate primary sector that applies to your cost share request

- | | | | |
|---------------------------------------|--------------------------------------|---|--|
| <input type="checkbox"/> Agritourism | <input type="checkbox"/> Aquaculture | <input type="checkbox"/> Honey Bees | <input type="checkbox"/> Fruits & Vegetables |
| <input type="checkbox"/> Horticulture | <input type="checkbox"/> Organics | <input type="checkbox"/> Value-added Products | <input type="checkbox"/> Viticulture |

4. PRIORITY AREAS Special requirements for 50% cost share

- Certification/attendance must be completed by the applicant. No substitutions, such as farm managers or relatives, are allowed.

AGRITOURISM		
Must have attended two events, listed below prior to reimbursement deadline. One event MUST be an Agritourism Conference or Direct Marketing Sense Course, sponsored by TDA/UT. Check those attended or planning to attend. A list of eligible events will be posted on the Producer Diversification web page in the Agritourism criteria sheet.		
Agritourism Conference	Direct Marketing Sense Course	Agritourism Workshop or Agritourism Bus Tour
<input type="checkbox"/> 2009 <input type="checkbox"/> 2010 <input type="checkbox"/> 2012	<input type="checkbox"/> 2010 <input type="checkbox"/> 2011 <input type="checkbox"/> 2012	<input type="checkbox"/> 2009 <input type="checkbox"/> 2010 <input type="checkbox"/> 2011 <input type="checkbox"/> 2012

FRUITS AND VEGETABLES	
Must have attended one of the following workshops listed below prior to reimbursement deadline. Check those attended or planning to attend. A list of eligible events will be posted on the Producer Diversification web page in the Fruits and Vegetables criteria sheet.	
GAP Food Safety Workshops	GAP Mock Audit
<input type="checkbox"/> 2010 <input type="checkbox"/> 2011 <input type="checkbox"/> 2012	<input type="checkbox"/> 2010 <input type="checkbox"/> 2011

HONEY BEES		
UT Master Bee Hobbyist (MBH) Course Course must be completed prior to reimbursement deadline.	Year Completed:	Where/County:
	Plan to attend?	<input type="checkbox"/> No <input type="checkbox"/> Yes

ORGANICS	
Must be USDA certified or working towards certification to qualify. Must be certified at time of reimbursement.	
1. List name and phone number of certifying agency below.	
2. Attach copy of certification or letter from certifying agency verifying that you are working towards certification.	
Certifying Agency:	Phone #:

Application B general instructions are available online at www.tn.gov/agriculture/enhancement or from your local extension office.

5. Application Proposal Maximum of 5 pages in length. See page 18 for program guidelines.

1) Briefly describe your agricultural operation.

- a. Industry sector (s)/type of business
- b. Years in business - (1) production agriculture and (2) other business involvement (e.g. agritourism, garden center, etc.)
- c. Number of employees - full, part-time, seasonal
- d. Acreage in production
- e. Sales income from on-farm production agriculture – based on sales for the last 3 years (2008, 2009, 2010)
- f. Sales income from other products, services, and/or events – based on sales for the last 3 years (2008, 2009, 2010)
- g. Types of products produced – currently and previously
- h. Indicate any expansions or downsizing – past, present, future

2) If you have applied for TAEP cost share previously, list each cost share received in the format provided below.

Fiscal Year	Program	Project Description	\$ Allocated/\$ Paid
FY10-11	Producer Diversification	Greenhouse	\$ 5,600 / \$ 5,485

3) Describe your proposed cost share project(s).

- a. List each proposed project (e.g., greenhouse, retail shelter, sprayer, Web site)
- b. List projected increase in annual income generated for the next three years as a result of your project(s)
- c. Explain how each project will improve or expand your operation
- d. Indicate whether you had help in planning this project from a county extension agent, industry expert, specialized group or association. List key individuals and their titles.

4) Outline the steps and time line for completing your project(s) by program deadline of May 1, 2012.

5) Summarize your marketing plan for your diversified agricultural products.

- a. List how and where your products are or will be sold
- b. Specify marketing activities that are currently utilized in your operation (e.g., auctions/organized sales, brochures, e-commerce, print media, radio, signs, television, Web site, etc.)
- c. Competitive advantage: Indicate what sets your product apart from your competitors

6) Provide a detailed, line-item budget for each proposed project using the format presented below.

- a. Research all costs associated with project(s). List each item and its cost on a separate line. Provide the source of the cost quote with a phone number or attach a written cost estimate from the vendor, with complete contact information for the vendor.
- b. Written cost estimates are required if projects are: large scale (e.g., greenhouse, retail shelter, restrooms), include many components (e.g., irrigation system), or involve labor.
- c. **LABOR:** In order to be eligible for cost share reimbursement, labor must be quoted and performed by a contractor. Labor is NOT eligible for reimbursement if performed by the applicant or their employees.
- d. Priority Cost Share (50%) - applicant must meet special requirements to be eligible.
- e. The total amount of cost share requested cannot exceed the maximum of \$10,000 (35%) or \$15,000 (50%). Minimum cost share reimbursement amount is \$250. *Follow sample budget format table below:*

Item Description	Source of Cost Quote	Cost	Cost Share %	Request
Greenhouse (16 x 95)	JR Construction – see attached quote	\$7,800.00	35%	\$ 2,730.00
Sign – vinyl banner	FedExKinko's 615-771-7999	\$ 225.00	50%	\$ 112.50
Total Amount of Cost Share Requested:				\$2,842.50

6. APPLICANT AGREEMENT

- I certify that I am a resident of Tennessee and that I am at least 18 years old on application date.
- I have reviewed and understand all of the guidelines listed in this application booklet.
- I certify that all the information on this application is complete, true and factual to the best of my knowledge and belief.
- I understand that providing any false, fraudulent or misleading information may result in penalties and/or make this farm/tract ineligible to participate in present and/or future Tennessee Department of Agriculture programs.
- I understand that the minimum cost share reimbursement request per program is \$250.
- I also understand that failure to utilize allocated funds can affect eligibility for future programs.

Print Applicant Name _____

Date _____

Applicant Signature _____

7. HOW TO SUBMIT "APPLICATION B"

- Fill in all blanks and check appropriate boxes where requested.
- Attach application proposal and cost quotes.
- Attach Substitute W-9 form (page 20).
- NO FAXES OR EMAILS ACCEPTED - Applications are only accepted by mail or hand delivery.

Mail to: TN Dept. of Agriculture
 Attn: TAEP FY2011-B
 P.O. 40627
 Nashville, TN 37204

Applications must be postmarked June 1 – 7, 2011 or hand delivered during the same period.

Applicant will be notified in writing of approval or denial of application. Allow 10 weeks for processing.

TAEP in Action

**\$48,759,574 Producer Cost Share Dollars
Invested in Tennessee Agriculture FY05-06 - FY09-10**

Cost Share Program	Number of Projects
Cattle Genetics	5,340
Livestock Equipment.....	8,435
Hay Storage	3,189
Livestock Feed Storage	1,023
Grain Storage	250
Producer Diversification.....	878
Total Number of Projects.....	19,115

5072 Producer Cost Share Projects Approved in FY10-11

Cost Share Program	Number of Projects
Cattle Genetics	1610
Livestock Equipment.....	2034
Hay Storage	985
Livestock Feed Storage	142
Grain Storage	139
Producer Diversification	162

Each TAEP dollar generates \$4.64 in local economies*

**Source: The University of Tennessee Agri-Industry Modeling & Analysis Group*



TAEP also provides funds for

- Public Farmers Markets
- County and Regional Fairs
- Statewide Ag Producer Associations
- Community Ag Learning Centers
- Agriculture Education Programs - Scholarships for Beef Quality Assurance Certification, Master Beef Certification, Master Meat Goat Certification, Master Bee Hobbyist Certification, Dairy Quality Milk Initiative Classes
- Farm Land Preservation - Funds to Help Defray Legal, Survey, and Appraisal Cost for Conservation Easements
- Forestry Programs - Urban Community Forestry, Master Logger Training, Reforestation
- Veterinarian Equipment Cost Share Program
- Livestock Market Cost Share Program
- Water Quality and Soil Conservation District Programs - Best Management Practices Educational Programs, Technical Support and Equipment

TAEP Contact Information

cattle.genetics@TN.gov
livestock.equipment@TN.gov
hay.storage@TN.gov
livestock.feedstorage@TN.gov
grain.storage@TN.gov
producer.diversification@TN.gov
vip.feedercattle@TN.gov
taep.outreach@TN.gov

Tennessee Agricultural Enhancement Program
Tennessee Department of Agriculture
Ellington Agricultural Center
P.O. Box 40627
Nashville, TN 37204

Information Line

1.800.342.8206

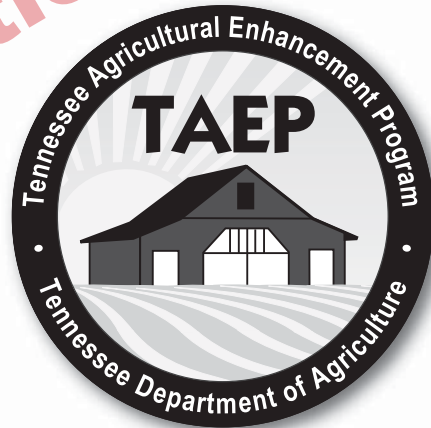

Physical Address
Ellington Agricultural Center
Holeman Building
440 Hogan Road
Nashville, TN 37220

 Tennessee Department of Agriculture. Authorization No. 325372, 35,000 copies, February 2011. This public document was promulgated at a cost of \$0.196 per copy.